

X24 ATEX/IECEx Telemetry User Manual

mantracourt.com



X24

Wireless ATEX/IECEx Telemetry

This user manual should be used in conjunction with the T24 Telemetry User Manual

Introduction / Overview	4
Navigating This Manual	4
Product Quick Locator	4
X24 and T24 Telemetry Basic Principles	5
Transmitters & Receivers	5
Transmitters.....	5
Receivers.....	5
Radio Channel and Group Key	5
Radio Channel	5
Group Key.....	5
Configuring Multiple Modules to Use the Same Radio Settings.....	6
ID and Data Tags.....	6
Transmitter Module Modes of Operation.....	6
Operational (Low Power Mode)	6
Operational (Non Low Power Mode)	6
Configuration.....	6
Sleep.....	6
Transmitter Module Sleep Delay Settings.....	7
Pairing	7
Pairing From T24 Toolkit.....	7
Pairing From a Receiver Module	7
Soft Pairing.....	8
Configuring an Attached Base Station	8
Asynchronous Operation and Logging.....	8
Bandwidth.....	9
Repeaters and Repeater Subgroups	9
T24 Toolkit	10
Common Toolkit Pages	11
Setup Base Station Communications.....	11
Analyser	12
Channel Monitor	13
Home	15
Connecting to a remote module.....	15
Connecting to the attached base station module	16
Manual Connection	16
Information.....	17
Battery and Radio Levels.....	18
Battery and Radio Levels Advanced	19
Radio Settings	20
Radio Settings Advanced.....	21
Save and Restore	22
Transmitter Modules	23
X24-ACMi-SA, X24-SAe, X24-SAi.....	23
Overview	23
Order Codes	23
X24-SAe.....	23
T24-ACMi-SA.....	23
Connections.....	24
X24-SAe, X24-SAi.....	24
Power	24
Sensor.....	24
X24-ACMi-SA	25
Power	25
Sensor.....	25
Configuration.....	26
Data Rates and Quality.....	26

Calibration	28
Calibration by Certificate.....	30
Calibration Advanced.....	31
Advanced Settings.....	32
Enclosure & Mounting	33
X24-SAe, X24-SAi.....	33
X24-ACMi-SA	33
Antennas.....	33
X24-SAe.....	33
X24-ACMi-SA	33
Specification	34
Radio Range.....	34
Receiver Modules	35
X24-HD.....	35
Overview	35
Order Codes	35
X24-HD.....	35
Connections.....	35
Power	35
Quick Start.....	36
Connecting Power	36
X24-HD.....	36
Transmitter Module	36
Viewing Transmitter Data.....	36
Operation.....	37
Keys	37
Indicators.....	37
Errors.....	38
Configuration.....	39
Modes of Operation	39
No List Entered (Default).....	39
List Entered.....	39
List Entered Plus Summing Groups	39
Global Settings	40
Configure Inputs	42
No Defined Transmitters.....	42
Defined Transmitters	44
General Tab.....	44
Zero Tab	46
Scaling Tab.....	48
Group Membership Tab.....	49
Summing Groups	50
General Tab.....	50
Zero Tab	52
Scaling Tab.....	53
Members Tab	55
Example Configuration Scenarios	56
Examples Using No Defined Transmitter List (Roaming Mode).....	56
Long Bridge	56
Brewery.....	56
Example of Defined Transmitter List	56
Single Transmitter	56
Multiple Transmitters.....	56
Example of Summing Groups	56
Alternative Units	56
Grouping Sums.....	57

Enclosure & Mounting	59
Antennas.....	59
Specification	60
Radio Range.....	60
Appendices.....	61
Appendix A - Enclosures	61
OEM Transmitter Modules.....	61
Dimensions.....	61
Opening the Case.....	61
Mounting Information.....	61
Antenna Position.....	62
Environmental Protection.....	62
ACMi Type.....	63
Dimensions.....	63
Opening the Case.....	63
Mounting Information.....	63
Antenna Position.....	64
Environmental Protection.....	64
Handheld Type	65
Dimensions.....	65
Opening the Case.....	65
Mounting Information.....	66
Antenna Position.....	66
Environmental Protection.....	66
Appendix B - Antennas.....	67
Overview.....	67
T24-ANTA.....	68
Mounting	68
Specification	68
Antenna Range.....	69
Appendix C - Radio Specification.....	70
Appendix D – CE, FCC and IC Approval Statements	71
CE.....	71
IC.....	72
FCC.....	73
Appendix E - OEM / Reseller Marking and Documentation Requirements	74
CE.....	74
IC.....	75
FCC.....	76
Appendix F - Worldwide Regional Approvals	77
Important Note	77
Appendix G – ATEX & IEC.....	78
Declarations and Attestations of Conformity.....	78
ATEX Examination Certificates	79
X24-SAe, X24-SAi.....	79
X24-ACMi-SA	82
X24-HD	84
IEX Ex Certificates of Conformity	86
X24-SAe, X24-Sai	87
X24-ACMi-SA	88
X24-HD	89
Appendix H - Warranty.....	90

Introduction / Overview

The X24 Telemetry range of products are ATEX and IECEx approved members of the larger T24 Telemetry product range. Systems can be put together using X24 in the hazardous areas and T24 in safe areas as required.

The radios operate on the licence free 2.4 GHz band and are approved for FCC, IC and European use.



The flexible transmission rates and low power usage allows for long battery/cell life for remote modules.

Free Toolkit software provides simplified configuration of modules and other free software provides logging and visualisation functionality for Windows PCs.

When using X24 products you will also need to refer to the **T24 Telemetry User Manual** and also be aware that X24 products are configured using the **T24 Toolkit** software in conjunction with a T24 base station.

Navigating This Manual

When viewing this PDF manual the following tips will help you navigate.

Viewing bookmarks ( or ) to the left of the page, in the PDF viewer, will allow easy navigation to the relevant chapters of this manual. Alt-left arrow is a useful shortcut back to the last page viewed after a hyperlink is clicked. Hyperlinks are coloured yellow and are underlined.

Product Quick Locator

This section allows you to locate your product quickly to navigate to the correct section of the manual.

Strain Input

[X24-ACMi-SA](#)

[X24-SAe](#)

Receivers

[X24-HD](#)



T24 modules cannot be used in hazardous areas!

X24 and T24 Telemetry Basic Principles

There are some basic radio settings and concepts that should be understood to effectively configure, deploy, optimise and troubleshoot X24 and T24 telemetry systems.

Transmitters & Receivers

Although all of the X24 modules are in fact transceivers and transmit as well as receive, they tend to mainly operate as either a transmitter or receiver so we will choose to describe them as **Transmitters** and **Receivers**. The X24 system was designed so that Transmitters are configured to send out messages at a user defined rate. Receivers can then use this data to analyse, display or perform other actions depending on their function. A PC and base station are only required to configure the modules although they may be part of a data collection system. Once configured the X24 modules operate autonomously and only minimal control over the Transmitter modules is usually required, by Receiver modules, such as sleeping or waking.

Transmitters

These are the sensor modules that measure inputs, such as strain, and send messages containing the sensor value and status information at regular intervals for use by Receiver modules or for delivering to a PC via a base station. Because these modules need to be very power efficient to operate on batteries they operate in three distinct modes. See [Transmitter Module Modes of Operation](#) later.

Receivers

These modules use messages provided by Transmitters and have functionality such as handheld displays, large displays, analogue outputs and relay modules. These modules may also offer control over Transmitter modules such as sleeping or waking. X24 currently has only one Receiver in the range (The X24-HD handheld display) but the X24 Transmitters can be used with any of the T24 Receivers.

Radio Channel and Group Key

To be able to communicate, two radio modules must share some basic settings. There are ways to learn these and to recover unknown settings and these are discussed later in the **pairing** section.

Radio Channel

This is the frequency that the radio operates on. Radio bandwidth is divided into 15 channels. Modules must be on the same channel to be able to transfer messages.

Group Key

Group keys are a way of isolating groups of modules even if they are operating on the same radio channel. This can improve efficiency and also offer security because no radio module can affect another or see their messages unless they share the same group key.

A group key is defined by the user and is up to 15 alphanumeric characters.

Group keys were introduced in v3.0 radio firmware in March 2015. New radio modules will work with older radio modules but group keys cannot be used.

Configuring Multiple Modules to Use the Same Radio Settings

Please note that when you pair to a remote module the base station adopts the radio channel and group key of the remote module.

To set the group key for a set of remote modules you can either:

Pair to each one in turn and set their radio channel and group key.

or

Configure the base station by holding the shift key and clicking the **Pair** button on the [Home](#) page. Then configure the base station to the required [radio settings](#) then use the tool on the [radio settings advanced](#) page to pair to each module in the set to configure their radio settings to match the base station.

ID and Data Tags

To configure a module its **ID** is used in communications. This is a unique 6 character identifier, such as **FF1234**, which is allocated at the factory. This ID is hexadecimal so can consist of numbers 0-9 and letters A-F.

If a module is a Transmitter it sends messages without broadcasting its ID. It identifies messages by using a Data Tag. This tag is a 4 character hexadecimal number and can be configured by the user. When modules leave the factory this data tag is set to the last 4 characters of its ID.

When Receiver modules or software want to use messages sent by Transmitter modules they identify the message they want by this Data Tag.

The reason Transmitter module messages are identified by a Data Tag rather than the unique ID is that this allows replacement of a Transmitter module without having to reconfigure the many Receiver modules that may be using its messages. It is only necessary to configure the replacement Transmitter module with the same data tag, radio channel and group key and the rest of the system will not notice the difference.

Transmitter Module Modes of Operation

Operational (Low Power Mode)

Normal mode involves taking a reading and sending a message then entering into a very low power state before taking the next reading to maximise battery life.

Because it is not possible to communicate with the Transmitter module during this low power state a 'Configuration' mode is required.

Operational (Non Low Power Mode)

If battery life is not an issue, modules are externally powered or transmission rates are so high that low power mode is not available then the modules do not enter a low power state between transmissions.

Configuration

Configuration mode forces the modules to pause in sending their messages and to disable their low power state to enable configuration to take place. This is easily achieved by '**Pairing**' when using the T24 Toolkit software. Once configuration is complete the modules will resume their '**normal**' mode operation.

Sleep

The last mode is sleep. Modules can be sent to sleep by other modules or they can go to sleep themselves when their messages are no longer being used. See [Sleep Delay Settings](#) later.

When sleeping, the modules can be awakened on demand by other modules or software via the base station.

Transmitter Module Sleep Delay Settings

Transmitter modules have a **Sleep Delay** setting (set in seconds) which allows the modules to go into Sleep mode when their data messages are no longer required. This allows much longer battery life to be achieved.

Setting Sleep Delay to zero disables this function in the Transmitter modules and they will only go into Sleep mode when told to do so.

Most Receiver modules and T24 software send **Stay Awake** messages when they see messages arrive from Transmitter modules. In the Transmitter modules, if the Sleep Delay time period has elapsed without a Stay Awake message arriving then the module will enter Sleep mode.

Usually the Stay Awake messages are sent every 5 seconds so Sleep Delays should be set to at least 10 seconds but can be set to anything up to an hour for situations where the Receiver is likely to be out of range for periods of time but where the Transmitter module is required to stay awake and in normal operational mode during that time. It is usual that Sleep Delays are set somewhere between 30 and 300 seconds when required.

Pairing

Because you need to know the radio settings configured in a module to be able to configure it, and there are no visible clues to what those settings may be, there is a feature used by X24 and T24 modules that enable the radio settings (i.e. the radio channel and the group key) to be determined and matched between two modules.

Pairing is only required to determine and match radio settings and optionally to put X24 Transmitter modules in **configuration mode**. Because in some installations the X24 modules can be buried deep inside other equipment there had to be a way of indicating that a module has been selected to pair with without having physical access to that module. Pairing was therefore designed to be activated by removing and re-applying the module's power. In some cases this is not practical so another possible solution is **Soft Pairing** see later.

Pairing From T24 Toolkit

When using the T24 Toolkit and a base station, pairing is used to connect to a module without having to know anything about it beforehand. To pair, remove power from the required module, click a 'Pair' button in the software and re-apply power to the module. The base station and module negotiate settings and the **base station is automatically configured to match the radio settings from the module** and places the module into configuration mode. Now the module can be configured and when complete it will return to normal operational mode.

Pairing From a Receiver Module

Some Receiver modules allow pairing to a Transmitter module without requiring the T24 Toolkit. For example some handheld readers offer this feature by turning them on while holding a certain key after which the power is applied to the Transmitter module. The radio settings are then negotiated and the **Transmitter module is automatically configured to match the handheld radio settings**. The handheld learns the ID and data tags required to be able to use messages from the Transmitter module. In this case no configuration mode is required so the Transmitter module simply continues to operate in normal mode but with altered radio settings.

Soft Pairing

Pairing by power cycling is absolute and will work under all circumstances. However, sometimes access to the power supply of a module that you want to pair to can be restricted, a module 20 meters up a tower for example, so the T24 Toolkit offers a way to *soft pair*.

To achieve this you need to know the radio channel and group key of the remote module and configure the base station to match this. You must also know the unique ID of the module and armed with this you can soft pair to the module. This works quite well with Receiver modules as they are not operating in low power modes but the software does need to try and change Transmitter modules from their normal operation mode into configuration mode.

This may not **always** work reliably in high traffic or high noise environments because there are a lot of messages that need to be sent between the base station and the remote module which can be upset by the presence of too many other messages on the same radio channel. If a connection cannot be made then power cycle pairing may be the only option.

Configuring an Attached Base Station

Because a base station is attached to your computer when you are using the T24 Toolkit you do not pair to it the same way as with other X24 and T24 modules. To configure the base station using the Toolkit hold the shift key and click the **Pair** button on the [Home](#) page.

Asynchronous Operation and Logging

Transmitters send their messages at a fixed user defined interval regardless of whether anything is listening. This **message interval** is timed from when the Transmitter has been woken or powered on so there is no synchronisation of when the actual measurement is taken between different transmitters.

If you are logging information from multiple Transmitters using multiple channel logging software you should be aware of how the software will store and record values.

The software stores the message values as they arrive from each Transmitter and when a log is to be recorded it is the last value received by each Transmitter that is used.

This means that the values that are recorded could have been measured at any point during the Transmitter message interval.

For example, if there are 10 Transmitters operating at 333ms message interval then when the values are recorded to the log file you can **only** be sure that those values had been recorded within 333ms of each other.

So if there is a requirement that recorded sets of readings are within a certain time of each other, then that time is the maximum message interval that should be set for the Transmitters regardless of the actual log interval of the software (Which should always be greater than the Transmitter message interval).

Bandwidth

Each radio channel (1-15) has a finite ability to carry information. When modules do not need to communicate with each other they can be configured on separate radio channels and do not affect each other.

However, when multiple modules are on the same radio channel, even if they use different group keys, they are all contributing to filling the available bandwidth.

Each message transmitted takes up around 3 milliseconds so if everything worked perfectly and all modules transmitted at just the right time and with no gaps between then there could only ever be 300 messages per second being transmitted on any one radio channel.

In reality there are factors that reduce this capacity.

Each module uses a technique to detect whether anyone else is transmitting before it transmits itself and this takes a finite time. There can also be interference from other sources that can delay module transmissions.

Because of the transmission rate flexibility of the X24 modules there could be a few modules transmitting messages at fast rates or many modules transmitting messages at slow rates or any combination of these.

Practically there is a limit of around 200 messages per second available per radio channel.

It should be noted that as the number of Transmitter modules increases there is more chance of message collisions and so more messages are lost (remember that the Transmitter modules are sending their messages out at regular intervals) thus reducing the average number of messages per second arriving per module.

So, for example, 2 modules may transmit at 100 times per second or 100 modules at a rate of 1 per second.

Repeaters and Repeater Subgroups

Repeaters are able to retransmit messages so that the repeated signal is stronger than the original and so can increase the range of systems or can bypass obstacles.

The repeater must be configured to operate on the same radio channel and use the same group keys as those modules it is repeating.

Because the radio traffic is effectively doubled by a repeater there is a mechanism to reduce unnecessary repetition of messages.

Sometimes a repeater will still see messages from modules that do not need to be repeated (Thus filling up available **bandwidth**) so both repeaters and all other X24 and T24 modules have a setting called the repeater subgroup.

By default all subgroup settings are set to zero. A repeater will repeat a message from all modules whose subgroup is either zero or matches its own subgroup. If a repeater subgroup is zero it will repeat messages from all modules.

This is a simple way to break down modules into smaller groups and control what messages get repeated.

Changing the repeater subgroup is not normally necessary unless the bandwidth is very full due to either many Transmitter modules being present or very fast transmissions from modules.

T24 Toolkit

To configure the modules you must use the **T24 Toolkit** software application. This can be downloaded from our web site or may be shipped with your products.

The software is suitable for all versions of Windows.

Run the installer and follow the prompts to install the software.

In the Toolkit all items that can be changed or interacted with by the user are coloured green.

To change a value just click on the relevant green item. You will then be presented with a new dialog window allowing you to change the value.

This may use a slider, text box or list to allow your new value to be entered.

A base station will also be required to configure the X24 and T24 modules. If you have a USB version of the base station (T24-BSu or T24-BSue) then you just need to plug this into a USB socket on your PC. If you are using an alternative base station then please refer to the appropriate section of the **T24 Telemetry User Manual**.

Common Toolkit Pages

These pages in the T24 Toolkit are applicable to all connected modules.

Setup Base Station Communications

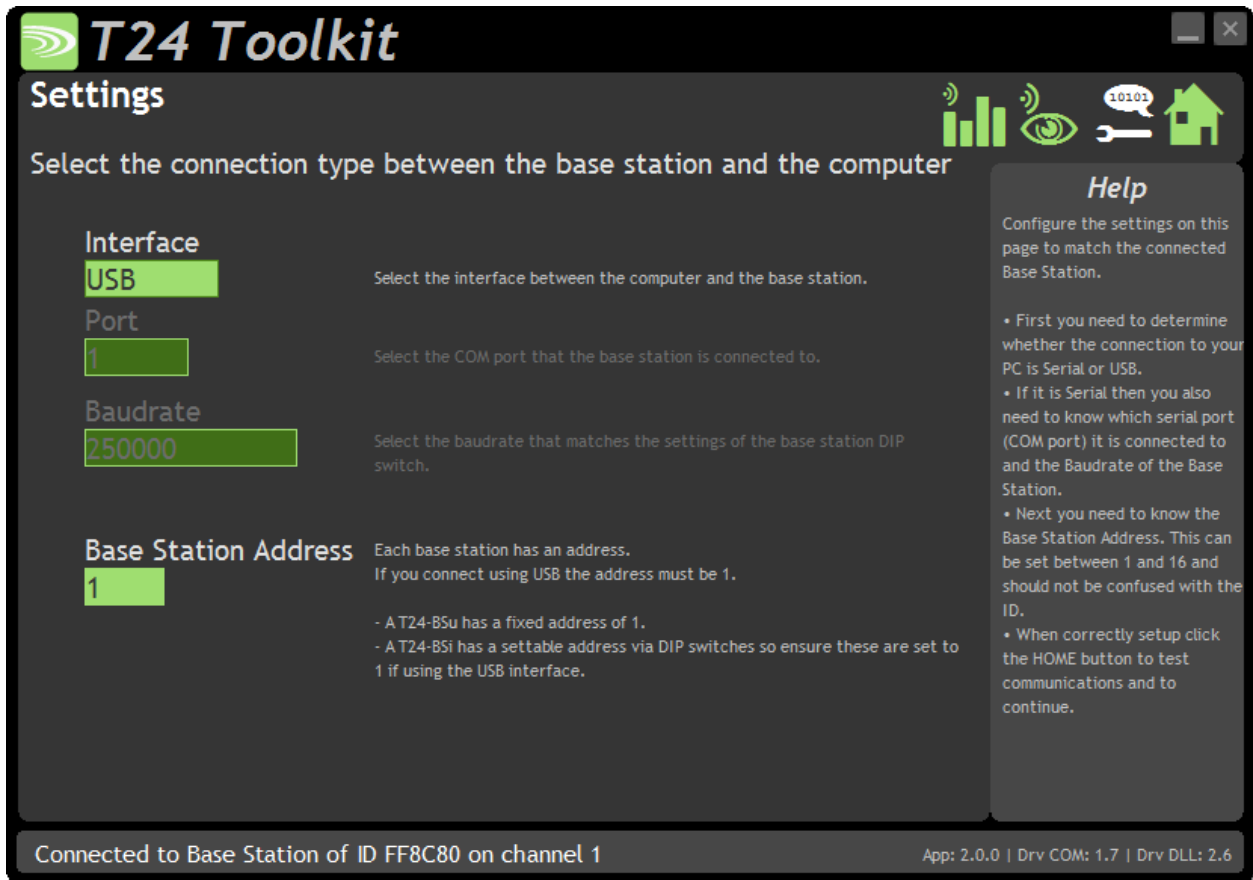

Select the appropriate interface type for the connected base station. If the base station is connected via a serial port then you will need to know the COM port it is connected to and the baud rate.

The Base Station Address is usually 1. This will only ever be different if it has been changed on base stations to support multi base station configurations.

Click the Home button to attempt communications with the base station.

If no communications can be established the toolkit will remain on this page. You will need to check that the base station is powered and that it is connected to any converters correctly.

Analyser

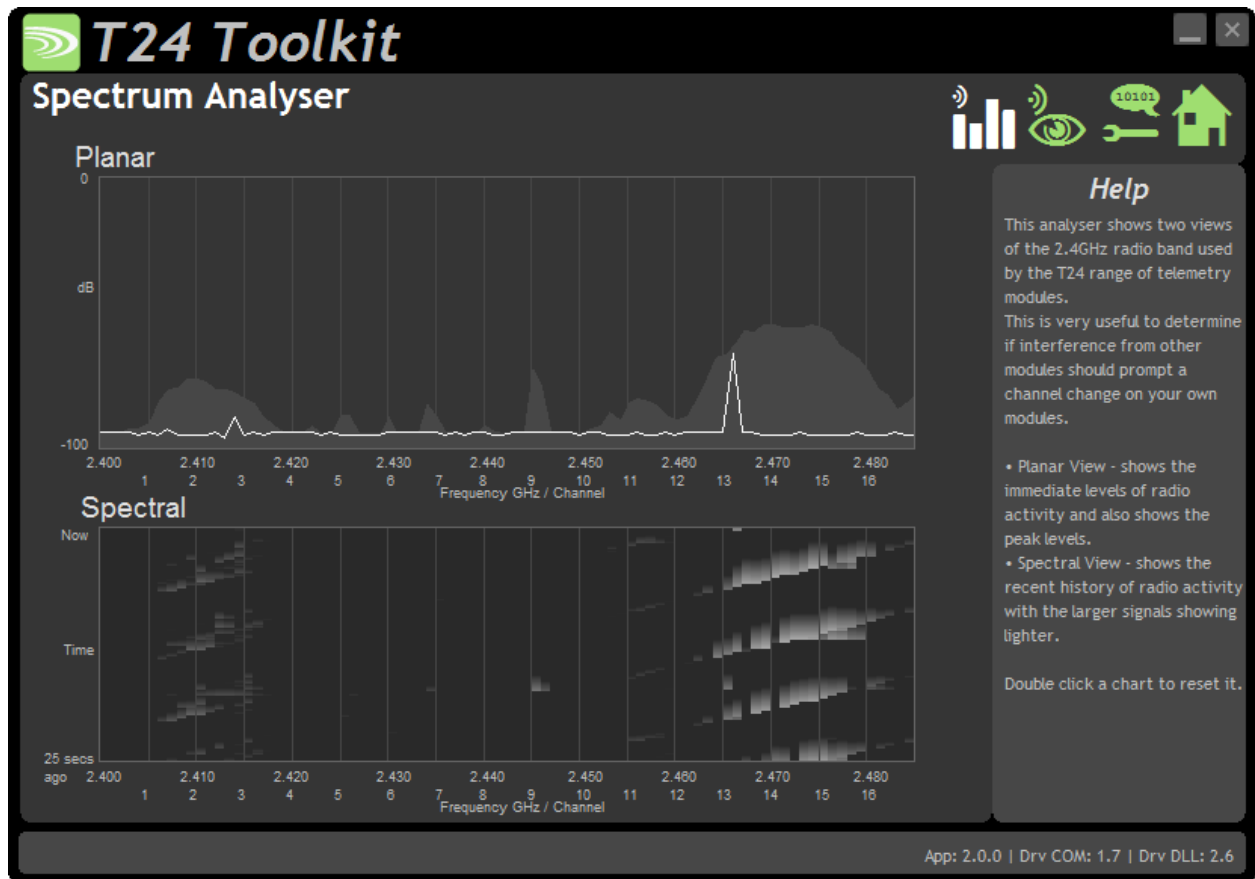

The analyser page is provided as a tool and will not normally be needed unless you plan to change channels and want to find the best channel to select, or to diagnose poor communications issues.

This page shows the radio signal levels detected across all the channels available to the X24 and T24 series of modules. Using this tool may help in detecting noisy areas and allow you to decide on which channels you may want to use.

The above charts show the traffic from a Wi-Fi network and it can be seen to be operating over channels 12 to 16 and it would be best (though not essential) to avoid using these channels.

Although 16 channels are shown the X24 and T24 modules operate over radio channels 1 to 15.

Channel Monitor

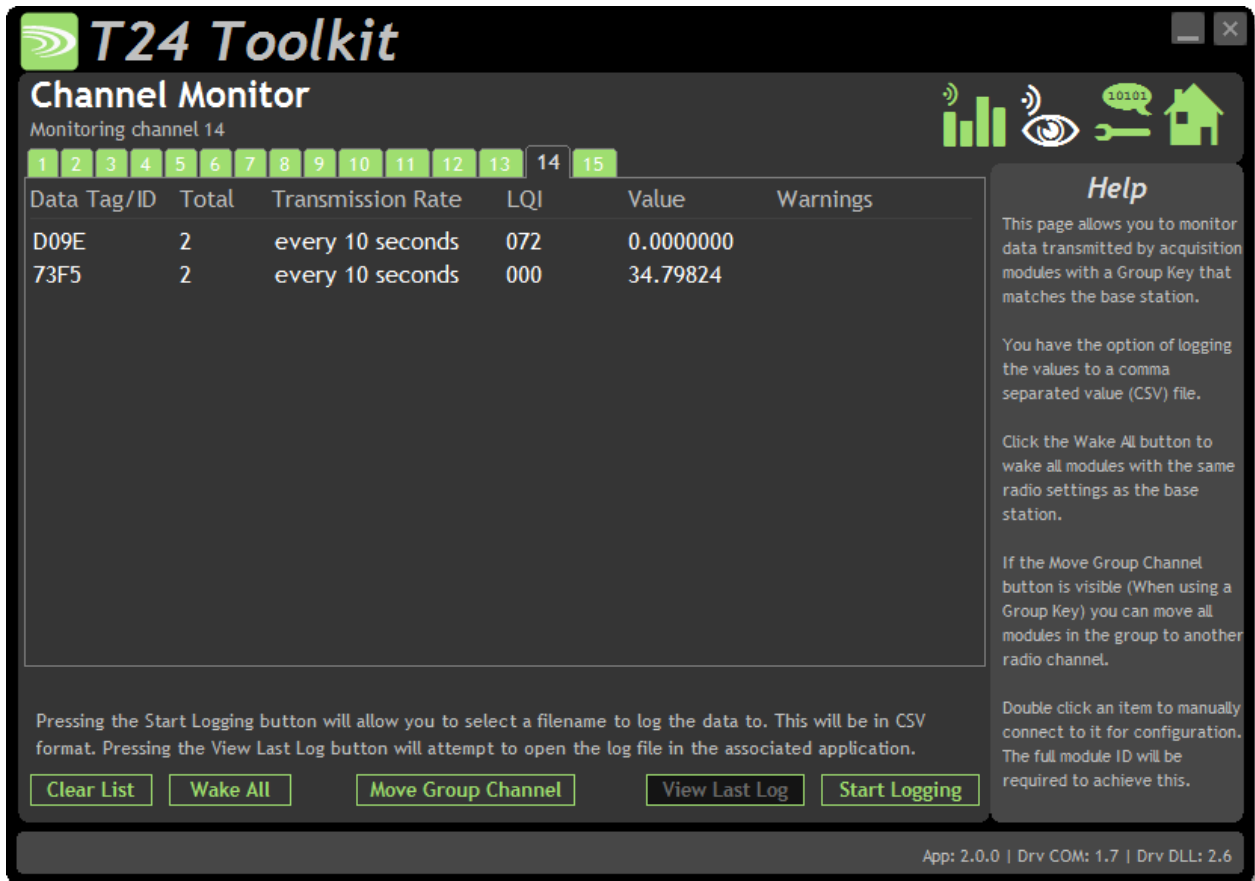

This page shows a summary of data sent by transmitter modules. You can see the Data Tag of transmitted messages along with the total number of messages received, the transmission rate, link quality, data value and any error messages. Some base stations can also list modules that are sleeping. These will show an ID instead of a Data Tag.

i To see any data the base station must be on the **same** radio channel as the transmitters **and** must have a **matching** Group Key

The radio channel of the base station can be changed by clicking the channel tabs along the top of the page.

If you want to change the Group Key of the attached base station you need to configure its radio settings. See [Configure Base Station](#)

Items you can change or interact with:

- Radio Channel Tabs Click a tab to change the radio channel the base station is operating on
- Clear List Clear all detected messages from the list
- Wake All Wake all modules on the current radio channel

Start Logging	Asks for a filename then logs the received data to a CSV file in the following format: Data Tag, Elapsed ms, Value
View Last Log	Will launch the application associated with CSV files and open the last logged file.
Move Group Channel	If the base station has a group key set then this button will be visible. Once at least one module is present in the list this button will become enabled. Clicking it will ask the user for a new radio channel then all detected transmitters, along with all other modules on the same channel and group key such as handhelds, will all be moved to the selected channel. Once this has been achieved the base station itself will move and the list will start to fill again with messages on the new radio channel.

 You will only see a list of detected transmitters on this page so you will need to ensure that any other receiver modules in the group are available to be woken.
When this button is clicked all modules on the same radio channel and group key will be woken before they are changed to the target radio channel.



You now have successful communications with the base station so you can now pair with your remote X24 module or you can select the Spectrum Analyser mode or Data Provider Monitor mode.

Connecting to a remote module

To connect to a remote module you will pair. This is achieved by power cycling the module. Pairing removes the need to know the radio settings of the module you are connecting to and also ensures that it is in a suitable state for configuration.

Pairing Procedure

- Remove power from the X24 module.
- Click the Pair button on the Toolkit.
- You now have 10 seconds to re-apply power to the X24 module.

If you connect successfully the Toolkit will change to the Information page. If the pairing fails try again.

i Pairing with the toolkit will **not** change the radio configuration settings of the connected module. The base station radio settings will be changed to match those of the remote module.

i When the toolkit connects to a remote module to enable configuration it will usually inhibit the normal operational transmission of messages

Connecting to the attached base station module

To connect to and configure the connected base station, hold the shift key and click the Pair button.

Manual Connection

If you cannot get to the power supply of the remote module you can attempt to connect manually using [Soft Pairing](#). Click the 'Click Here' link at the bottom of the page and follow the prompts.



The screenshot shows the 'T24 Toolkit' software window. The title bar reads 'T24 Toolkit'. The main window has a dark background with a top toolbar containing icons for a window, a wrench, a signal, a lock, a folder, an information icon, and a home icon. The 'Information' section on the left shows a photo of a yellow handheld device labeled 'ATEX Handheld Display'. To the right of the photo, the following information is displayed: ID: FF36D4, Model: X24-HD, Firmware Version: 1.00, Radio Module Firmware Version: 3.4, and Name: [redacted]. Below this is a 'Features:' section with five items: 'Protected Calibration' (greyed out), 'Supports Group Keys' (green), 'Using Group Key' (greyed out), 'Can Monitor Sleeping Modules' (greyed out), and 'Extended Range/Coverage' (orange). A 'Help' panel on the right contains text about viewing information and allocating names. At the bottom, a status bar shows 'Connected to X24-HD of ID FF36D4 on channel 1' and 'App: 2.3.0 | Drv COM: 2.0 | Drv DLL: 2.7'.

Once successfully paired to a module this page is displayed showing you information about the connected module.

Items you can change:

Name

You can enter a short description which may help you recognise this module in the future.

Features

Each module may support certain features which are indicated on this page. If the feature is greyed out then it is not supported. If it is coloured then it is supported.

Protected Calibration

Some transmitter modules may have had their calibration protected. This indicates that you cannot calibrate this module.

Supports Group Keys

[Group Keys](#) were introduced in 2015 so modules built before this date will not support this feature. This indicates that the connected module can support them

Using Group Key

This indicates that the connected module can support Group Keys and that one has been configured for this module

Can Monitor Sleeping Modules

Applicable to a base station only. This indicates that on the [Channel Monitor](#) page modules that are sleeping will also be listed

Extended Range/Coverage

Extended range radios were introduced to the T24 range in 2015. This indicates that the connected module has an extended range radio fitted.

Battery and Radio Levels

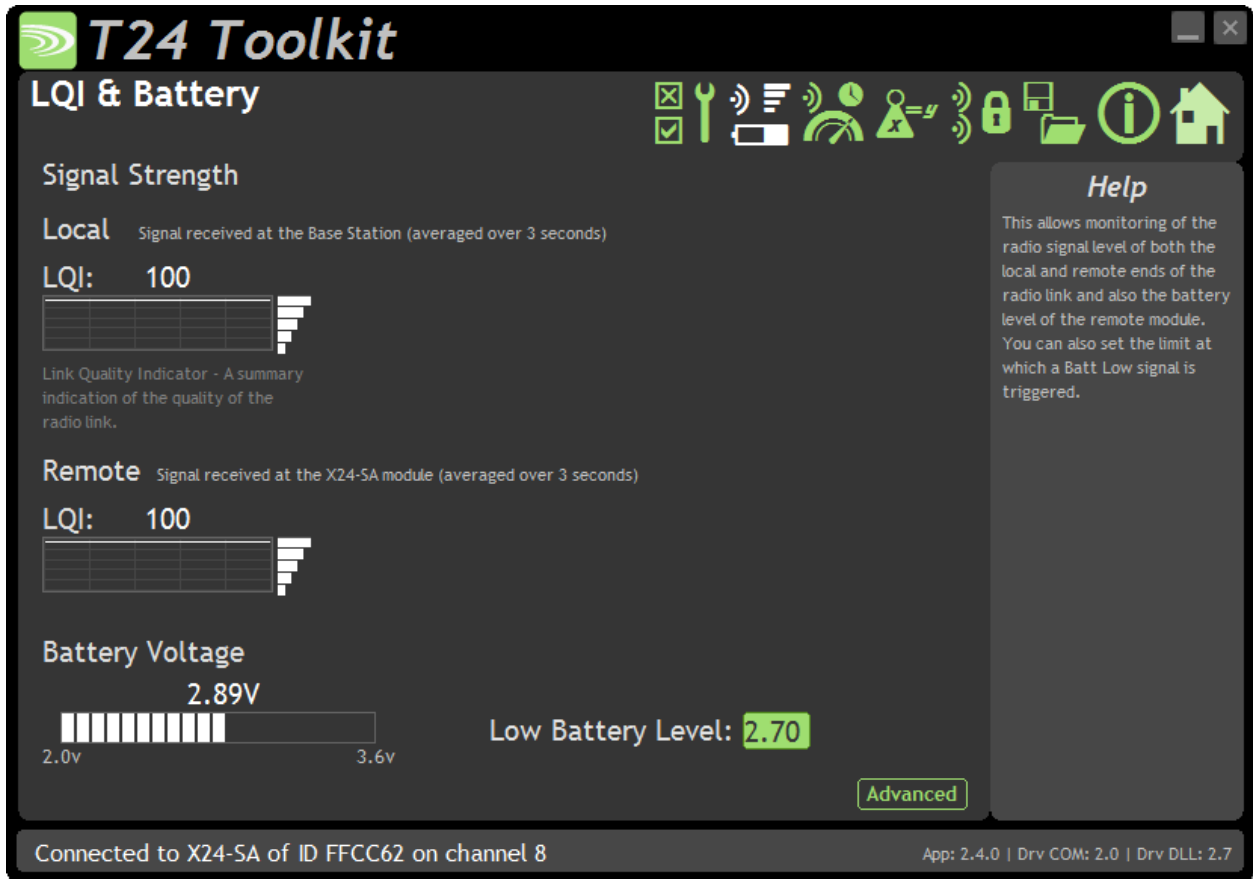

Available for Transmitters only. Here you can see the voltage of the battery and the radio signal levels at the base station and the remote transmitter module. This simple view gives an LQI value which stands for Link Quality Indicator. This value will range from 0 to 100 and within this band you should still achieve communications. As the level drops towards zero communications may become intermittent but still achievable.

On modules that are battery powered the battery voltage section will be visible. You can set the level at which the transmitter module reports a low battery. (At 2.1 V the module will stop working) If the battery voltage is below the Low Battery Level the bar will be coloured orange.

Items you can change:

Low Battery Level

Click this item to set the battery low level. For the Energizer L91 cells this should be around 2.7 V.

Clicking the Advanced button will give more detailed information on the RSSI and CV levels of the received radio packets.

Battery and Radio Levels Advanced

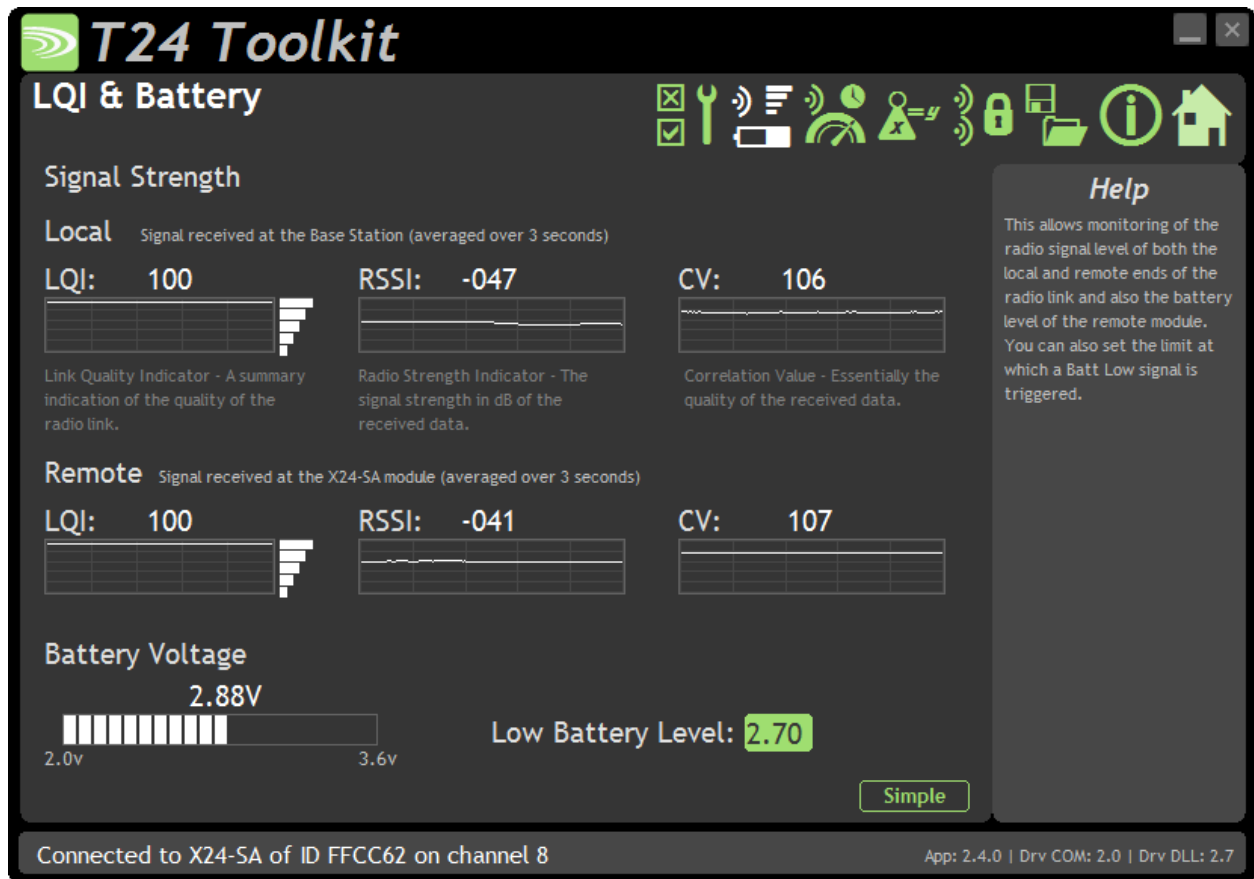

LQI value which stands for Link Quality Indicator. This value will range from 0 to 100 and within this band you should still achieve communications. As the level drops towards zero communications may become intermittent but still achievable. This is calculated from the RSSI and CV values.

RSSI is effectively the received dB level which will range from about -30 which is a good signal to -98 which is a weak signal.

CV is the correlation value and indicates how well the signal can be decoded. This ranges from 55 which is a poor quality signal and 110 which is an excellent signal.

Radio Settings



Here you can change the channel and group key for the connected module.

Items you can change:

Channel Select a [radio channel](#) between 1 and 15. The default is channel 1. You can use the [Spectrum Analyser](#) mode to determine a good clean channel to use.

Group Key **Only visible on modules that support [Group Keys](#).** Only modules with identical group keys can communicate. You can isolate groups of modules on the same channel or just use the key to ensure the data cannot be read by somebody else. Early versions of T24 modules do not support Group Keys and this option will not be visible in the Toolkit.

To use modules that support Group Keys with older modules that do not then the Group Key field must be blank.

The following two options are not visible when changing radio settings for a base station. In that case changes are immediate.

Reset Module Only **Only enabled once a change has been made.** When radio settings are changed they do not take effect immediately but require a reset or power cycle. This button forces the connected module to adopt the new settings but keeps the base station on the existing settings. The home page is then shown.

Reset Module and base Station **Only enabled once a change has been made.** When radio settings are changed they do not take effect immediately but require a reset or power cycle. This button forces both the connected module and the base station to adopt the new changes and re-establishes a connection.

Radio Settings Advanced

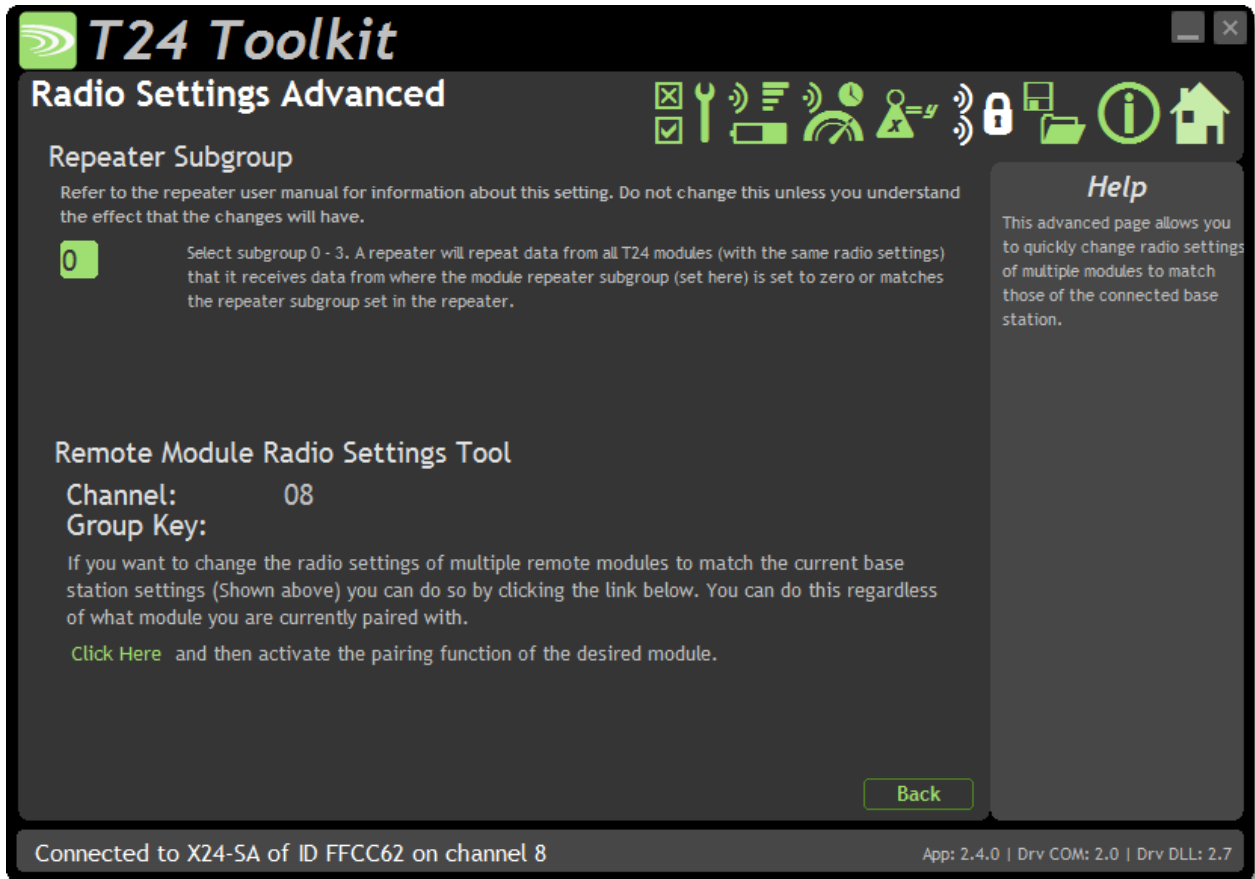

Here you can change the repeater subgroup settings for the connected module. Also a tool is provided to quickly match remote module radio settings to the base station radio settings.

Items you can change:

- | | |
|-----------------------------------|--|
| Repeater Subgroup | Select a repeater subgroup for this module. The default is zero which will let all repeaters repeat messages from this module. See Repeaters and repeater Subgroups |
| Remote Module Radio Settings Tool | <p>To quickly set a batch of remote modules to match the radio settings of the base station you can use this tool. Usually this is arrived at by pairing with the base station by holding the shift key whilst clicking the Pair button on the Home page.</p> <p>To change the remote module radio settings:</p> <ul style="list-style-type: none">• Remove remote module power• Click the Click Here link on the page• Apply power to the remote module <p>The Toolkit will remain unchanged and still paired to whatever module or base station it was paired to but the remote module will have changed its radio settings.</p> |

Save and Restore

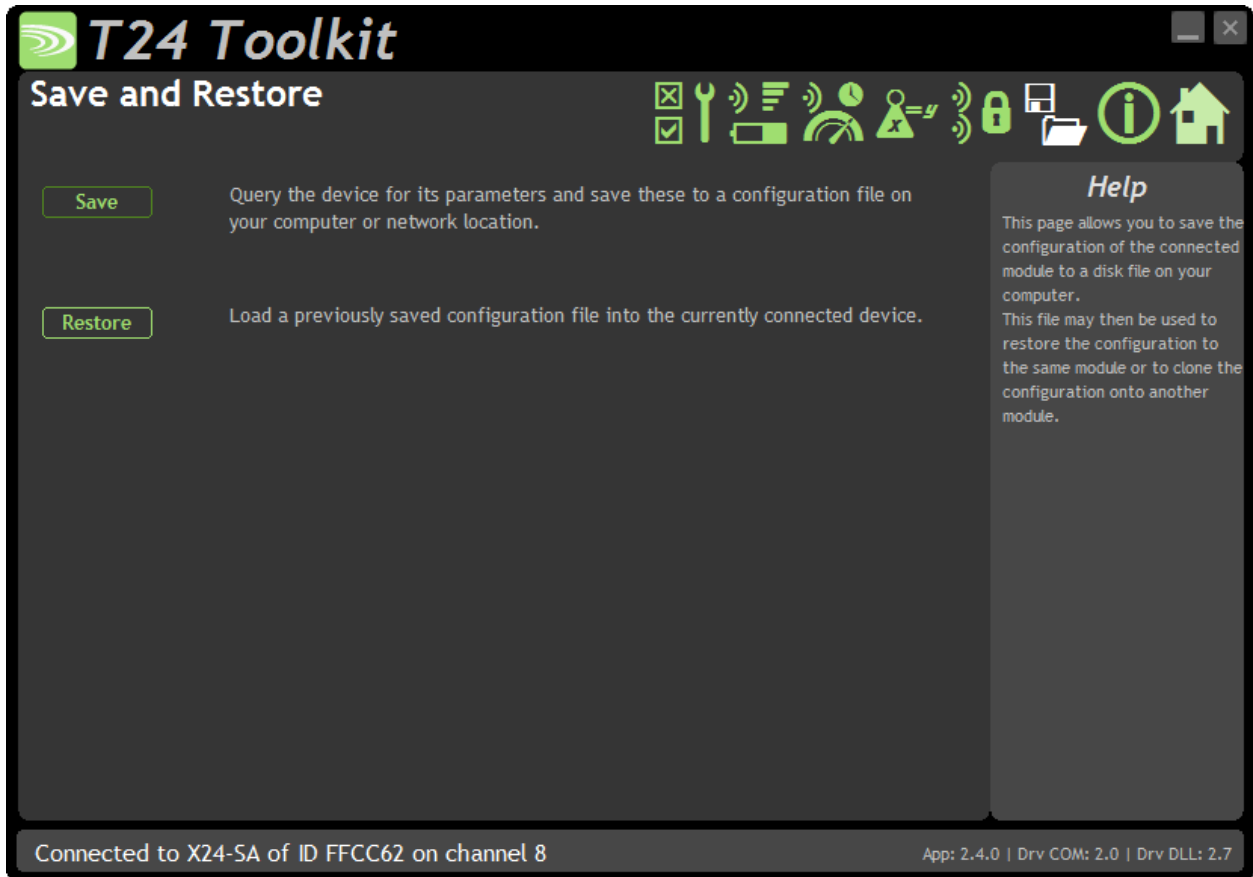

Here you can save the module settings to a file on your PC so that they can be later loaded back into the same or different module.

Items you can change:

- | | |
|---------|--|
| Save | Click this button to open a file dialog window to allow you to select a filename and location to save the configuration file to.
All configuration information including calibration data will be saved to the file.
The file extension is tcf . |
| Restore | Click this button to open a file dialog window to allow you to select a filename and location of a previously saved file to load into the connected module.
All configuration information including user calibration data will be overwritten.
The file extension is tcf . |

Transmitter Modules

X24 Transmitters are the modules that connect to a sensor or have an input signal applied and periodically transmit messages containing the value read from the sensor or input.

X24-ACMi-SA, X24-SAe, X24-SAi

Overview

The range of SA modules provide measurement from strain gauges and load cells. Formats available are component OEM modules or enclosed versions.

Order Codes

X24-SAe

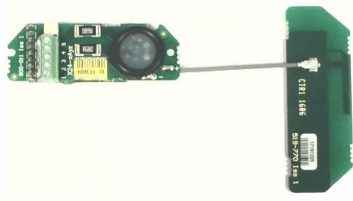

OEM strain transmitter module with external PCB antenna on 60mm UFL cable.

X24-ACMi-SA



Strain transmitter module mounted in weatherproof enclosure with battery holder for two Lithium Energiser L91 AA batteries.

Connections

X24-SAE, X24-SAI

Power

Attach power supply wiring to the module as shown below:

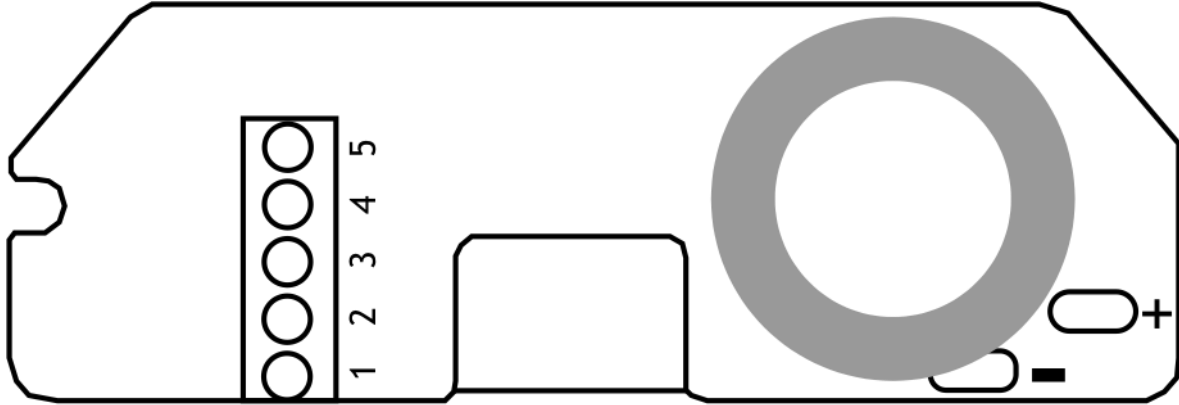

Connect to a 3 V power supply or batteries to the solder pads marked + and -.

For power requirements refer to the entity parameters:

Supply parameters Groups I, IIC, IIIC

U _i	3.66V
I _i	340mA
P _i	1.244W
C _i	43μF
L _i	5.64μH

Sensor

Strain gauge connection is 4 wire as follows:

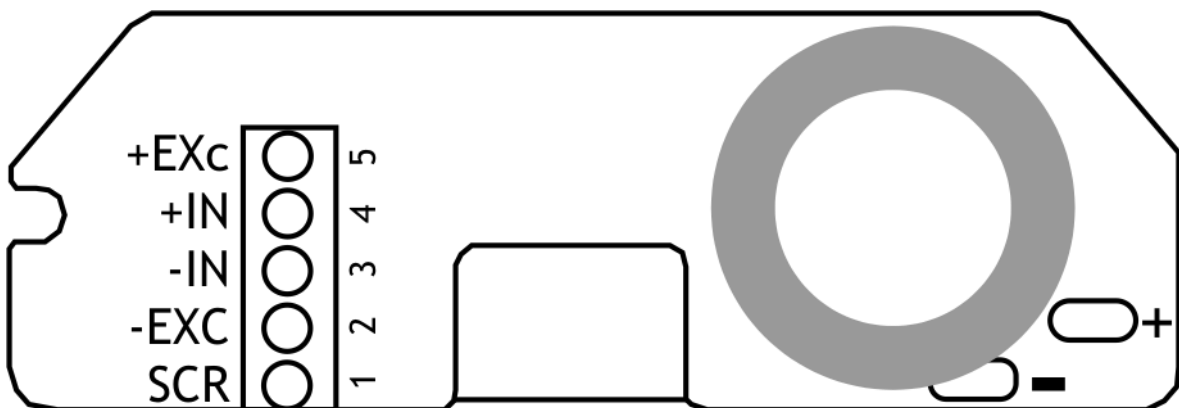

The resistance of the strain gauge can be between 85 and 5000 ohms. The X24-SA can support up to four 350 ohm strain gauges bridges attached in parallel (At the expense of reduced battery life).

The cable lengths between the X24-SA and the gauges should be kept below three meters and generally as short as possible.

As the measurement is four wire then as the cable length increases the voltage drops in the cable will have more of an effect on the factory mV/V calibration.

The strain gauge measurement is bi-directional, i.e. tension & compression.

Refer to the following entity parameters:

Sensor connector parameters

Groups I, IIC, IIIC

Uo	5.5V
Io	2.25A
Po	1.25W
Co	15µF
Lo	1.38µH

X24-ACMi-SA

Power

The enclosure is designed to accept two Energizer L91 AA lithium batteries.

! Use only Energizer L91 cells. Do not change cells in an explosive atmosphere!

Sensor

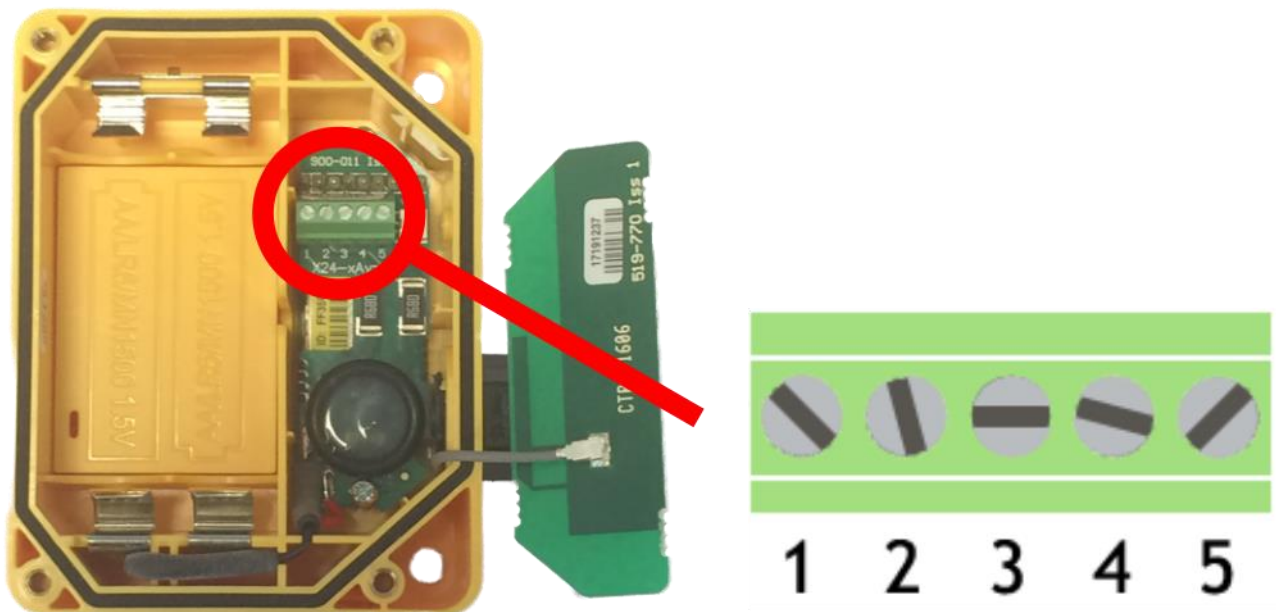

The input connections are accessed by lifting the right hand cover plate, this plate incorporates the X24 Antenna; take extra care when re-assembling that the grey UHF cable is attached to the antenna socket.

Screw Terminal	Function
1	Shield
2	- Excitation
3	-Signal
4	+Signal
5	+ 5 V Excitation

Configuration

The T24 Toolkit provides a means of simple configuration and calibration of the transmitter module along with useful tools to aid integration.

Launch the T24 Toolkit software application and pair to this module to enable the connection to the Toolkit to allow configuration to take place. [See Common Toolkit Pages - Home](#)

Data Rates and Quality

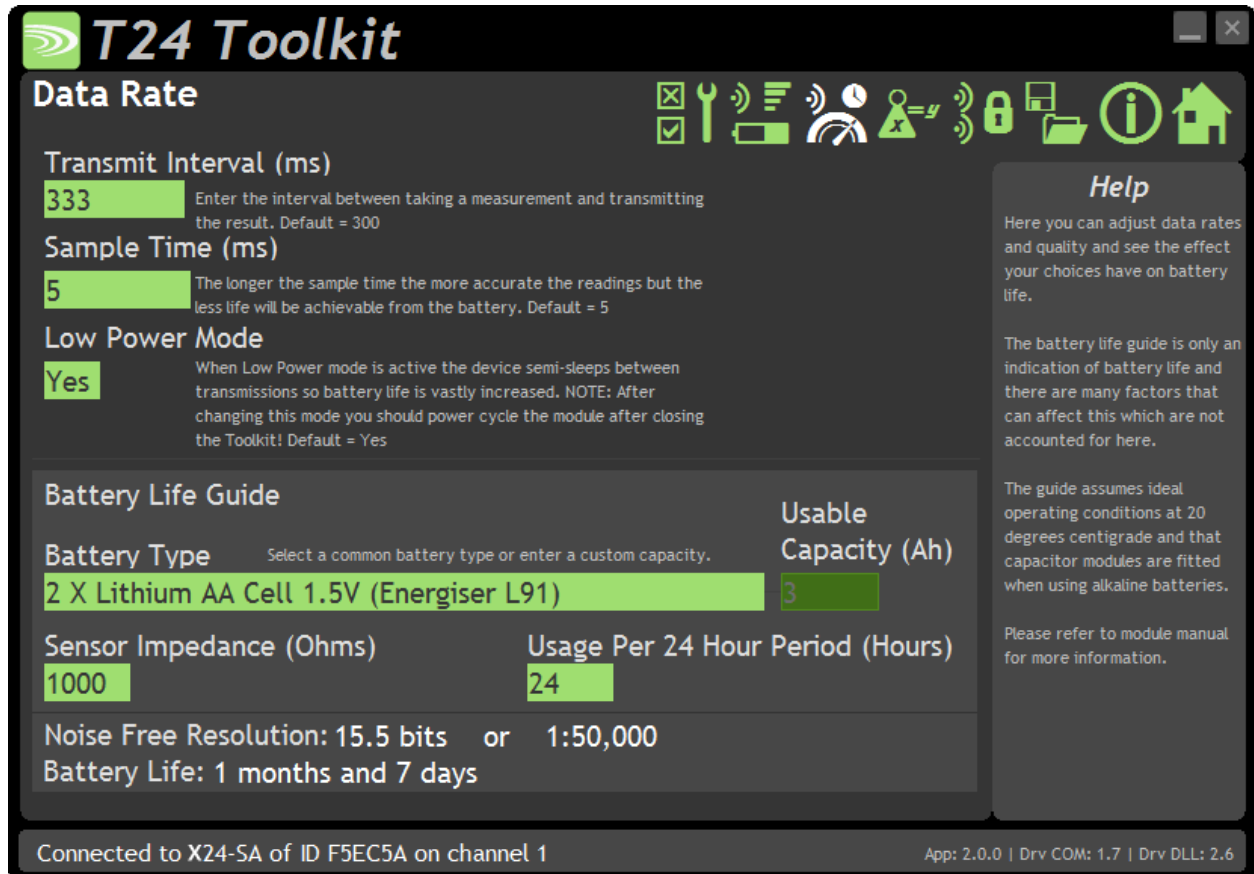

This page allows you to select the rate at which data is transmitted from the transmitter module and the quality. By selecting low power mode and entering some other information the toolkit will also give guides on achievable battery life.

Note that the battery life calculator is assuming the best case scenario which is at 20 °C.

Items you can change:

- | | |
|-------------------|--|
| Transmit Interval | Enter the transmission rate in milliseconds. The default is 333 giving approximately 3 per second which is ideally suited to reading on a handheld. You may want to slow this down to achieve longer battery life. |
| Sample Time | This is the length of time in milliseconds that the input is sampled before the value is transmitted. This can vary between 5 milliseconds and close to the Transmit Interval. A shorter sample time means that the module is awake for less time so battery life is increased but at the expense of a reading with less noise free resolution. You can vary this to see the effect on battery life and noise free resolution. |
| Low Power Mode | Unless the transmitter module is non battery powered this should be set to Yes. In between transmissions the transmitter module will enter sleep mode which, |

for some modules such as the strain gauge transmitter module, will have a massive effect on battery life.

A reason for **not** using Low Power Mode would be if using the module in a Master-Slave arrangement with PC for example.

Battery Type	This is not a parameter of the module but information used by the battery life guide. You can choose from either the certified AA batteries or choose custom to allow you to select your own battery capacity. See below. This will also offer to change the Battery Low Level if the level suitable for the chosen battery is not the level currently set.
Usable Capacity	This is not a parameter of the module but information used by the battery life guide. This is the capacity of the battery in amp hours and has a profound effect on battery life calculations. This capacity needs to be calculated from battery manufacturer's data sheets to take into account that you can only use batteries down to 2.1 volts so in the case of twin AA cells this would be 1.05 volts. Generally the usable capacity will not be as high as that advertised by the battery manufacturer. Temperature and internal resistance of the battery are not taken into account in the guide.
Sensor Impedance	This is not a parameter of the module but information used by the battery life guide. Enter the resistance of the connected strain gauge in ohms.
Usage Per 24 Hour Period	Enter the number of hours per 24 hour period that the Transmitter will be awake and transmitting.

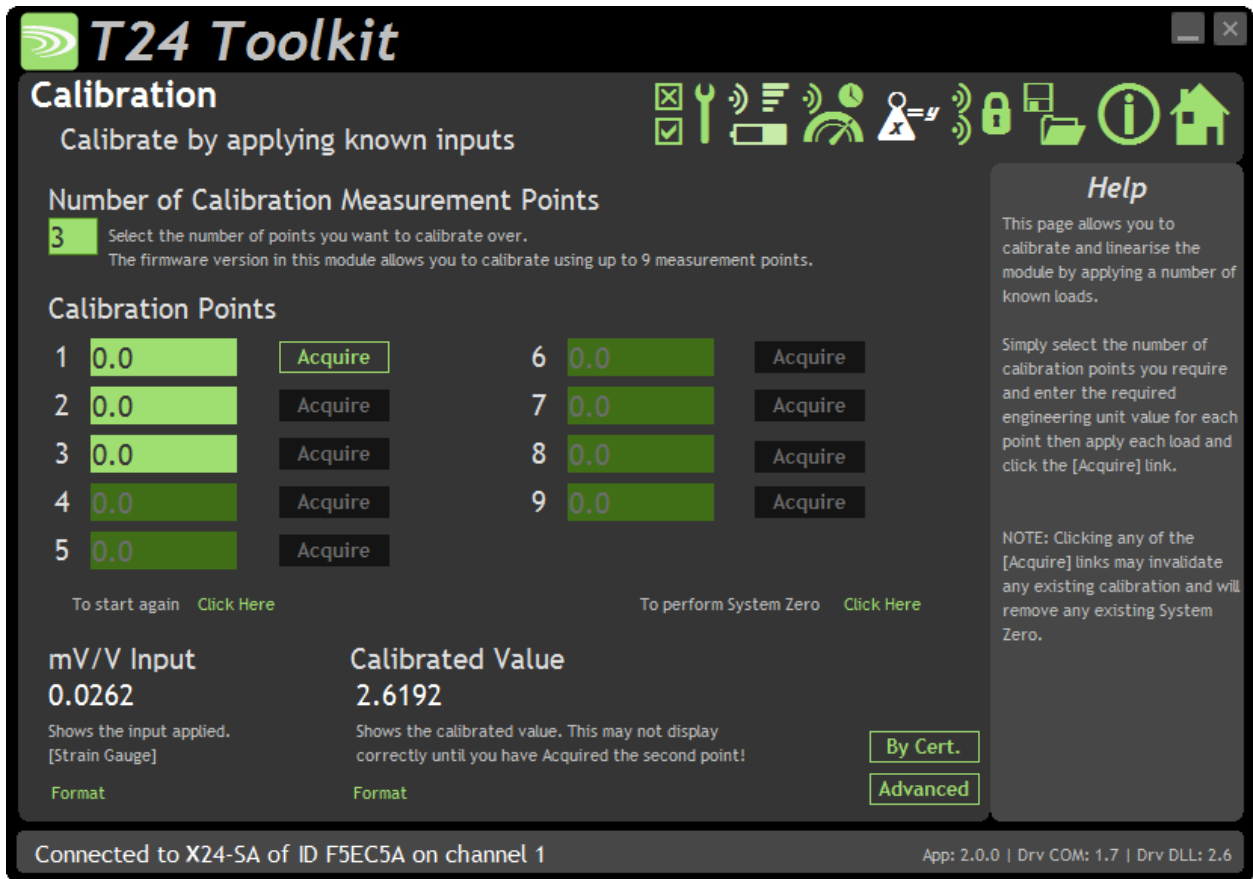

Here you can calibrate the transmitter module and set a system zero if required. This simple page allows semi-automated calibration where you can apply known inputs to calibrate. This calibration includes linearization and is automatically applied. See later for **By Cert** and **Advanced** page where you can adjust individual gains and offsets.

Calibration Process

- Decide on how many points you will calibrate over.
- Decide what weights will be applied (in ascending order) at each point.
- Enter the actual input (in the required units) that you want the module to read at each point.
- Now proceed to apply each input in turn (allowing a settle time) and click the **Acquire** button at that point. You can now apply the next input and click **Acquire** until all the points are completed.

i *The mV/V from the load cell must be ascending through each calibration point.*

The bottom of the page shows the **Input Value** and the **Calibrated Value**. Once the second point has been acquired this **Calibrated Value** should display the actual calibrated value.

Items you can change:

Number of Calibration Points Enter the number of points you wish to calibrate over. In its simplest form you could select two for a linear calibration. For more complex calibrations which include linearization select three to nine points.

Point 1 - 9 For each point enter the engineering unit value that you want the transmitter module to report at the applied input. i.e. 1.67

Acquire 1 - 9	Click this button when the input has been applied and the reading has been allowed to settle. This will acquire the reading and allow you to move to the next points. You will be able to click the button again to re-acquire.
Start Again	Click here to restart the calibration.
System Zero	Once calibrated you may want to remove a fixed system value. In the case of a strain gauge input this may be the weight of a sling, shackle, load bed etc. Apply the required input and click here to set the system zero. The current input will be removed from subsequent readings so that the reading will be zero. To edit this value manually click the Advanced button. System Zero is stored in non-volatile memory in the transmitter module.
By Cert.	You can click the By Cert button to calibrate against a sensor calibration sheet. You just need to enter the input values and associated engineering unit required output value of at least 2 points. This will take you to a different screen .
Advanced	Clicking the advanced button will allow you to edit the gains and offsets for each available calibration point. This will take you to a different screen .



The calibration for this transmitter may be locked in which case you will not have access to these pages!

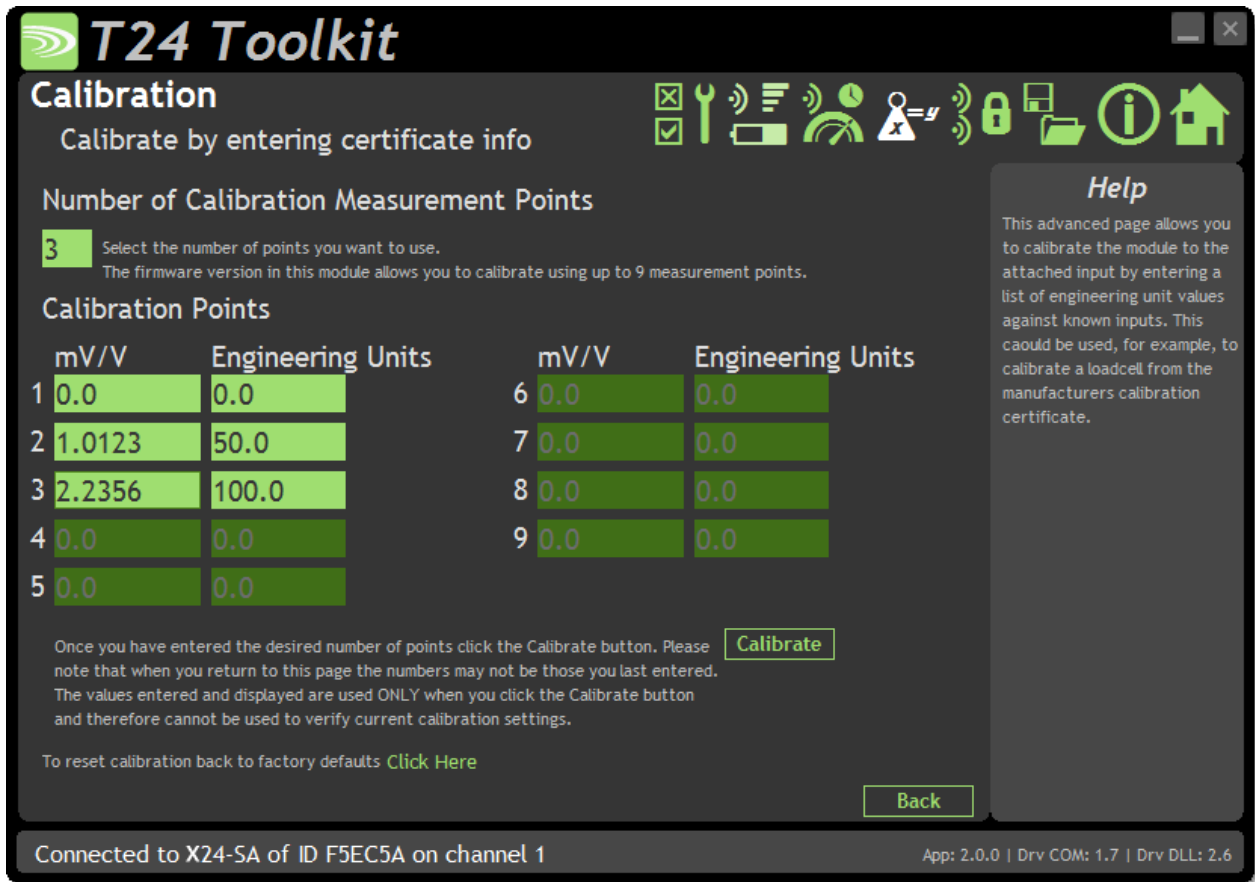

In some circumstances it may not be possible to apply inputs in which case the calibration can be entered manually from the calibration table or certificate for a load cell without ever having to connect the load cell.

Items you can change:

- Number of Calibration Points Enter the number of points you wish to calibrate over. In its simplest form you could select two for a linear calibration. For more complex calibrations which include linearization select three to nine points.

- Input Points 1 – 9 (mV/V shown in this screenshot) Enter the input point for which you will specify a required engineering output value
- Engineering Units 1 - 9 Enter the required engineering unit output for the specified input value

- Calibrate Click this button to calculate and update the module calibration

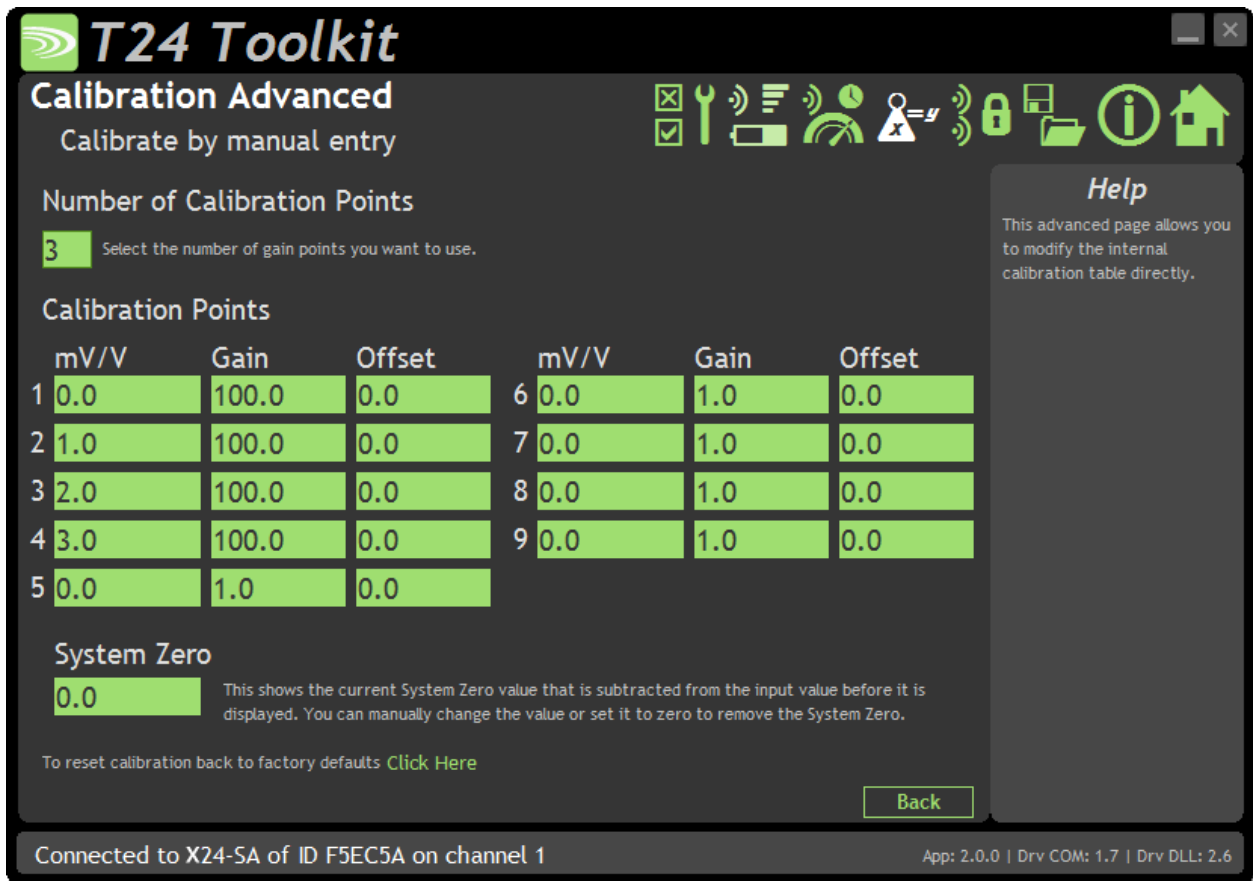

In some circumstances it may not be possible to apply inputs in which case the calibration can be entered manually.

For example, if a strain gauge manufacturer provides a calibration table for a cell it may be possible to calculate gains and offsets and enter these values into the Advanced Calibration page without having to connect the strain gauge or apply weights.

Items you can change:

Number of Calibration Points Enter the number of points you wish to calibrate over. In its simplest form you could select two for a linear calibration. For more complex calibrations which include linearization select three to nine points.

Input Points 1 – 9 (mV/V shown in this screenshot) Enter the input point to which the associated interpolated gain and offset values will be applied. Note between points the gain and offset values are linearly interpolated. Inputs are extrapolated below point 1 and above point 9.

Gain 1 - 9 Enter the gain value for associated point

Offset 1 - 9 Enter the Offset value for associated point

System Zero You can set the system zero value here or set it to zero to remove the system zero effect.

Description of Linearisation Calculations

The input value is looked up in a table of points starting from point 1. If the input mV/V is greater than the mV/V specified at that point then it is checked against the next point. When the best point has been found the Gain and Offset values from that point are applied to the mV/V value as follows.

$$\text{Value} = (\text{input} * \text{Gain}) - \text{Offset}.$$

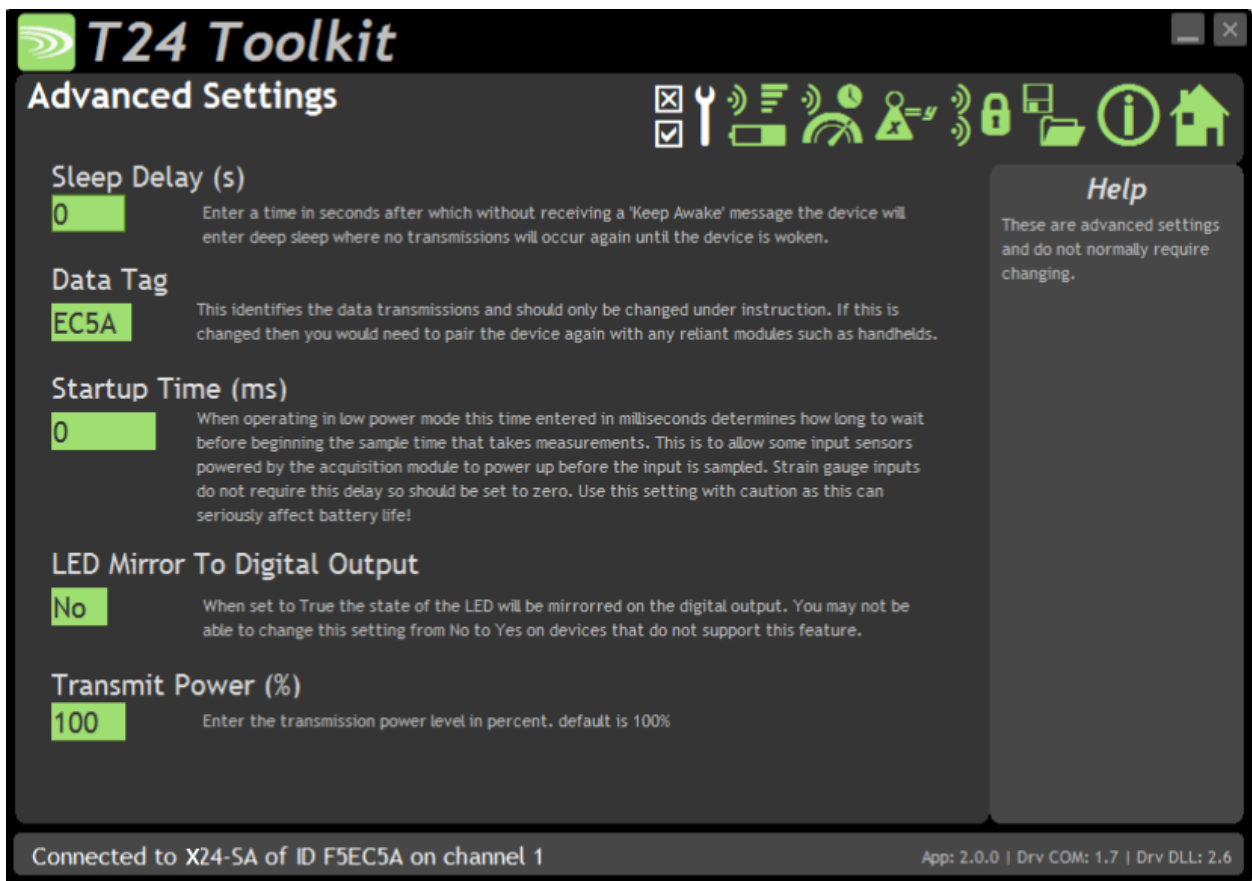

You should not normally need to change these settings.

Items you can change:

Sleep Delay	Here you can enter a delay in seconds after which the transmitter module will return to deep sleep if no Keep Awake message is heard from the X24-HD handheld. The default is 60 seconds. Enter zero to disable automatic sleeping.
Data Tag	The data transmitted by the module is identified by a Data Tag. This is by default set to the last 4 digits of the module serial number. If by some chance you had two transmitter module modules that would be working on the same channel and had the same last 4 characters in their ID (1 in 65,535 chances) you may want to change the data Tag of one of the modules and perform pairing again with the X24-HD handheld.
Startup Time	Some transmitter modules power a sensor from their excitation voltage. When coupled to a sensor with a slow startup time this setting is used to delay the measurement after wakeup from sleep between readings. This gives the sensor time to settle at the expense of battery life. For strain gauge inputs this settings should be set to zero.
LED Mirror to Digital Output	When set to Yes the large LED will flash indicating a transmission, configuration mode or when a handheld is looking at this Transmitter. This is very useful when using an X24-HD handheld as the transmitter module LED will activate while the handheld is in communications with the module.
Transmit power	Set the transmit power level from 0 – 100%. Default is 100%

Enclosure & Mounting

This module is available in different enclosure types. Locate your module and follow the link to view dimensional and mounting information for that particular enclosure.

X24-SAe, X24-SAi

These OEM modules are bare PCB modules. Please see [Appendix A – Enclosures & Mounting – OEM Transmitter Modules](#) for more information.

X24-ACMi-SA

This module is fitted inside our medium enclosure. Please see [Appendix A – Enclosures & Mounting – ACMi](#) for more information.

Antennas

X24-SAe

The X24-SAe module has an external antenna attached.

T24-ANTA PCB Antenna See [Appendix B – Antennas – T24-ANTA](#)

X24-ACMi-SA

These modules have the antenna already fitted inside the enclosure so there are no specific mounting requirements.

Specification

Specification with 1000R bridge, 2.5mV/V, at 3V supply at 25°C

Measurement	Min	Typical	Max	Units
Strain Gauge Excitation System			4 Wire	
Strain Gauge Excitation Voltage	4.5	5	5.25	Vdc
Strain Gauge Drive Capability	85	-	5000	Ω
Maximum Gauge Sensitivity (FR)			3.1	+/-mV/V
Offset Temperature Stability		1	4	ppm/°C
Gain Temperature Stability		3	5	ppm/°C
Offset Stability with Time		20	80	ppm of FR (1)
Gain Stability with Time			30	ppm of FR (2)
Non Linearity before Linearization		5	25	ppm of FR
Internal Resolution		16,000,000/ 24		Resolution/Bits
Noise Free where Sample Time < 10ms		50,000 / 15.5		Resolution/Bits
Noise Free where Sample Time < 50ms		65,000 / 16		Resolution/Bits
Noise Free where Sample Time < 100ms		150,000 / 17.25		Resolution/Bits
Noise Free where Sample Time < 1000ms		250,000 / 18		Resolution/Bits
Noise Free where Sample Time > 1000ms		400,000 / 18.75		Resolution/Bits

1. From original offset at any time.
2. First year.

Environmental	Min	Typical	Max	Units
Operating temperature range	-20		+50	°C
Storage Temperature	-40		+85	°C
Humidity	0		95	%RH

Power Supply	Min	Typical	Max	Units
Standby / Low Power Mode		5	20	μA
X24-SAe, X24-SAi, X24-ACMi-SA				
Power Supply voltage	2.1	3.0	3.6	Vdc
Power Supply ripple			50	mV ac pk-pk
Normal Mode (1K Bridge)		60	65	mA (1)

1. Power supply must be capable of supplying 300 mA for 250 μs (Required on start up, waking and during low power operation)

Battery Life in Low Power Mode Generating Results at 3Hz with 350R Load Cell	Usage	Battery Life
Pair Energizer L91 Lithium AA cells	Constantly on	30 days
Pair Energizer L91 Lithium AA cells	12 sessions per day of 5 minutes	2 years

Radio Range

To determine radio range please refer to [Appendix B – Antenna Range](#)

Receiver Modules

Receiver modules use the messages sent by the transmitter modules. These modules may process or display this information or convert the data into a different physical format. There are many more **non** ATEX/IECEX Receivers in the T24 Telemetry range that will work with X24 Transmitters.

X24-HD

Overview

The X24-HD is a highly configurable handheld display capable of working with X24 or T24 Transmitter modules. This allows wireless remote viewing of various remote inputs such as strain gauge or voltage etc. using 2.4 GHz radio.

The remote transmitter module measures its input value (strain gauge, voltage, current etc.) and periodically transmits it.

The X24-HD captures this data and displays it. The handheld can operate by displaying data from any transmitter detected or you can define up to 24 specific transmitters to allow the operator to cycle through.

Grouping functions allows up to 8 group totals to be viewable. Each group or individual transmitter has user defined name, scaling, display format, zero functions and overload settings.

Order Codes

X24-HD



Handheld display module in a robust weatherproof enclosure.

Connections

Power

The handheld module is powered by two lithium Energizer L91 AA batteries.



Use only Energizer L91 cells. Do not change cells in an explosive atmosphere!

Quick Start

This section will show you how to get the handheld and a Transmitter working out of the box. You will require two Energizer L91 AA lithium batteries for the handheld and a 3 V dc supply for the transmitter module which may also be a pair of AA batteries.

Connecting Power

X24-HD

Remove the two screws on the rear battery compartment. Insert two AA batteries. Refit the battery compartment cover. The handheld module is now switched on and will display **BUSY** until it detects a Transmitter.

Transmitter Module

See the relevant transmitter module manual section for information about connecting power.

Viewing Transmitter Data

The factory default setting for the handheld is that no specific Transmitter modules are configured so it will display data from any Transmitter on the same radio channel and using the same Group Key.

If you have purchased the handheld and Transmitter module at the same time then both will default to radio channel 1 and a blank Group Key.

Once power has been applied to the Transmitter the handheld will briefly display its Data Tag then show its value on the LCD. If you have more than one Transmitter then pressing the Next key (Triangular arrow) will move to the next available Transmitter.



Note that when no Transmitters are specified as inputs the handheld will wake up sleeping Transmitter modules as it detects them but it will not send them to sleep. After the handheld is turned off the Transmitters will remain awake. Use Sleep Delay setting in Transmitters to ensure they turn off again when the handheld is turned off or moves out of range.

Operation

Keys

The keys have two functions. A short press is a press and release. A long press is press and hold for around 2 seconds.



Power Key

Long Press – Powers the handheld on and off. Hold the power key until the display shows BUSY then release the key.

Quick Press - Toggle the backlight on and off when in manual backlight mode.



Next Key

Short Press - Step to the next Transmitter or group. A brief prompt will be displayed before the value is shown which will either be the Transmitter Data Tag or a user defined name.

Long Press - Display the Data Tag or name of the currently viewed Transmitter or group without moving to the next.



Tare Key

Short Press - This will toggle between gross and zeroed net mode. i.e. If the display shows gross then pressing the key will zero the display. Pressing the key when in net mode will return the display to gross mode. The Gross and Net modes are indicated as described below. Gross and Net states are retained through power off.

Long Press - When in net mode will briefly display the Gross value but remain in net mode.

Indicators

G

The display is showing Gross weight.

NET

The display is showing Net weight.

SIG LOW

The radio signal from the transmitter module is low. The module is still functioning but the limit of the range may be near. Communications may start to deteriorate when this indicator is visible. Until ----- is displayed the communications are still OK and the display can be relied on for accuracy.



Even with a degraded signal the display value will always be correct.

BATT LOW

The batteries in the handheld are low and need to be replaced.

REMOTE ERROR

The transmitter module has an error that the handheld does not recognise.

REMOTE BATT LOW

The battery or supply to the transmitter module is low.

Errors

Displayed on handheld LCD.

- Error 1** The transmitter module has a strain gauge input and is in shunt calibration mode. An external module has placed the transmitter module in Shunt Calibration mode so rather than display a misleading reading this error is displayed instead. Modules such as the X24-SA support this error type.
- Error 2** Input integrity error. The transmitter module has found a problem with the input. There may be open or short circuits. Rather than display a misleading reading this error is displayed instead. Only certain transmitter modules support this error such as the X24-SA.
- Overload** The overload limit set by the user has been exceeded.

Configuration

The T24 Toolkit provides a means of simple configuration of the handheld module along with useful tools to aid integration.

Launch the T24 Toolkit software application and pair to this module to enable the connection to the Toolkit to allow configuration to take place.

Remove a handheld battery (Not in hazardous area!), click Pair in the Toolkit and replace battery to perform a full pairing. This will work regardless of the radio settings in either the base station or the handheld.

If you know that the radio channel and group key settings of the base station and the handheld are the same you could soft pair to the handheld by performing a manual pair in the Toolkit and just entering the ID of the handheld.

[See Common Toolkit Pages - Home](#)

Modes of Operation

The handheld will allow you to view data from multiple transmitters and also allow the viewing of the sum of multiple transmitters. How the handheld operates depends on how you configure its list of transmitters ('Inputs') and optional summing groups.

When the handheld is turned on it will wake all transmitters using the same radio channel and group key if you have selected this feature.

No List Entered (Default)

In its simplest, out of the box, configuration the handheld has no transmitter inputs specified. In this mode the handheld will display data from any transmitter using the same radio channel and group key. To make things easier you can set a list Set Size so that the Next key just cycles around the n highest signal transmitters. This has a useful effect when setting the list size to 1 in that you can walk up to a transmitter, press the Next key and effectively select that one for viewing (as that will be the highest signal transmitter detected). As the different transmitters are cycled through, their Data Tags will be displayed briefly before their transmitted value is shown. In this mode the transmitters should have their Sleep Delay settings enabled so that they go back to sleep after the handheld is turned off or out of range as the handheld will wake all transmitters but not send them back to sleep. (Equivalent to the roaming capability of the T24-HR handheld)

List Entered

When you know which transmitter or transmitters are in your system (or you want to limit viewing to a certain collection of transmitters) you can enter up to 24 in the handheld's list of transmitters. The advantage over *not* having a list is that you can name each transmitter so their name is shown on the display instead of their Data Tag as they are selected. You can also configure each input separately for overload, format and scaling etc. In this mode, if the option to sleep and wake transmitters is enabled, the transmitters will be sent to sleep when the handheld is turned off.

List Entered Plus Summing Groups

Once you have entered at least one transmitter input in the list you also have the option of creating summing groups. Up to eight groups can be defined and any of the inputs can be defined as belonging to any of the groups. In this mode the Next key cycles around the groups instead of the individual inputs. Each summing group will display the summed total of all its constituent inputs. Groups have user defined names as well as overload levels, scaling and formats. Unless disabled you can also 'drill down' and look at the groups constituent inputs.

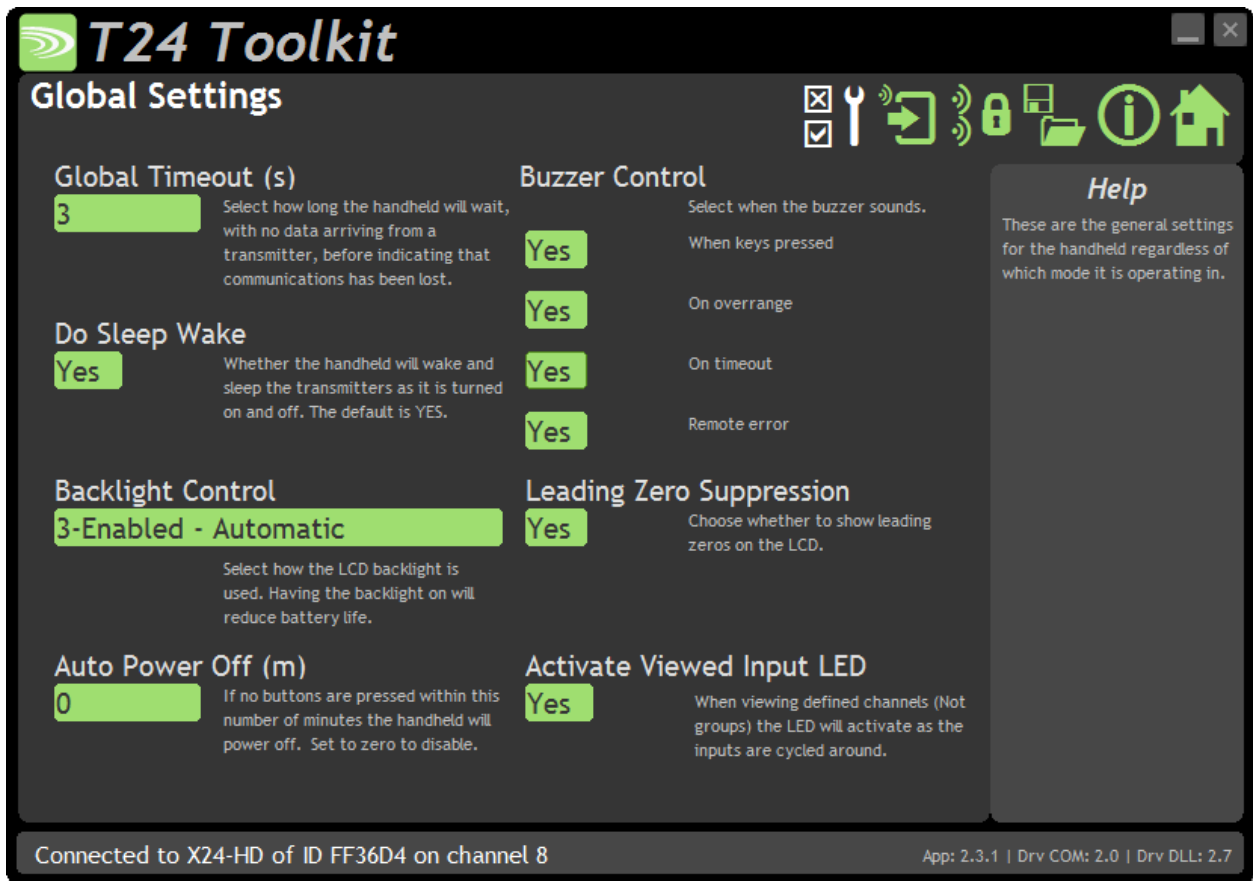

Here you can adjust the settings common to all modes of operation.

Items you can change:

- Global Timeout (s) This is how long the handheld will wait with no data received from the viewed transmitter before indicating that the signal has been lost. This should be set to at least twice the slowest transmitter interval.

- Do Sleep Wake Select this feature to enable the handheld to wake and sleep transmitters. When no transmitters are defined all sleeping transmitters (on the same radio channel and using the same Group Key) will be woken as they come into range of the handheld. Transmitters will not be sent to sleep regardless of this setting. When transmitters have been defined the handheld operated a little differently. For the first 12 seconds after turning the handheld on **all** transmitters will be woken (not only those defined). But on turning off the handheld the transmitters in the list will be sent to sleep.

- Backlight Control Select whether to disable or enable the backlight. If enabled you can chose to turn it on as soon as the handheld turns on and have control over its state using the power key (short press) or you can choose to operate automatically whereby the light comes on when a key is pressed and goes off after 30 seconds.

- Auto Power Off Set a time in minutes after which the handheld will turn off if no keys have been pressed. Set to zero to disable this feature. Will require a power cycle to change.

- Buzzer Control Here you can select whether the buzzer will sound when certain states are active.

- Leading Zero Suppression This will remove leading zeros from displayed values in all modes.

Activate Viewed Input LED When no transmitters are defined the transmitter currently being viewed will always activate its LED regardless of this setting. When any transmitters are defined then the transmitters LEDs will only activate when being viewed if this setting is activated.

i *Although this setting is OK to use with all X24 transmitters this feature should be disabled when being used with T24 transmitters with firmware versions below 04.00 as their LEDs may remain on when turning off the handheld.*

Configure Inputs

No Defined Transmitters

This page will be displayed when no transmitter list has been defined.

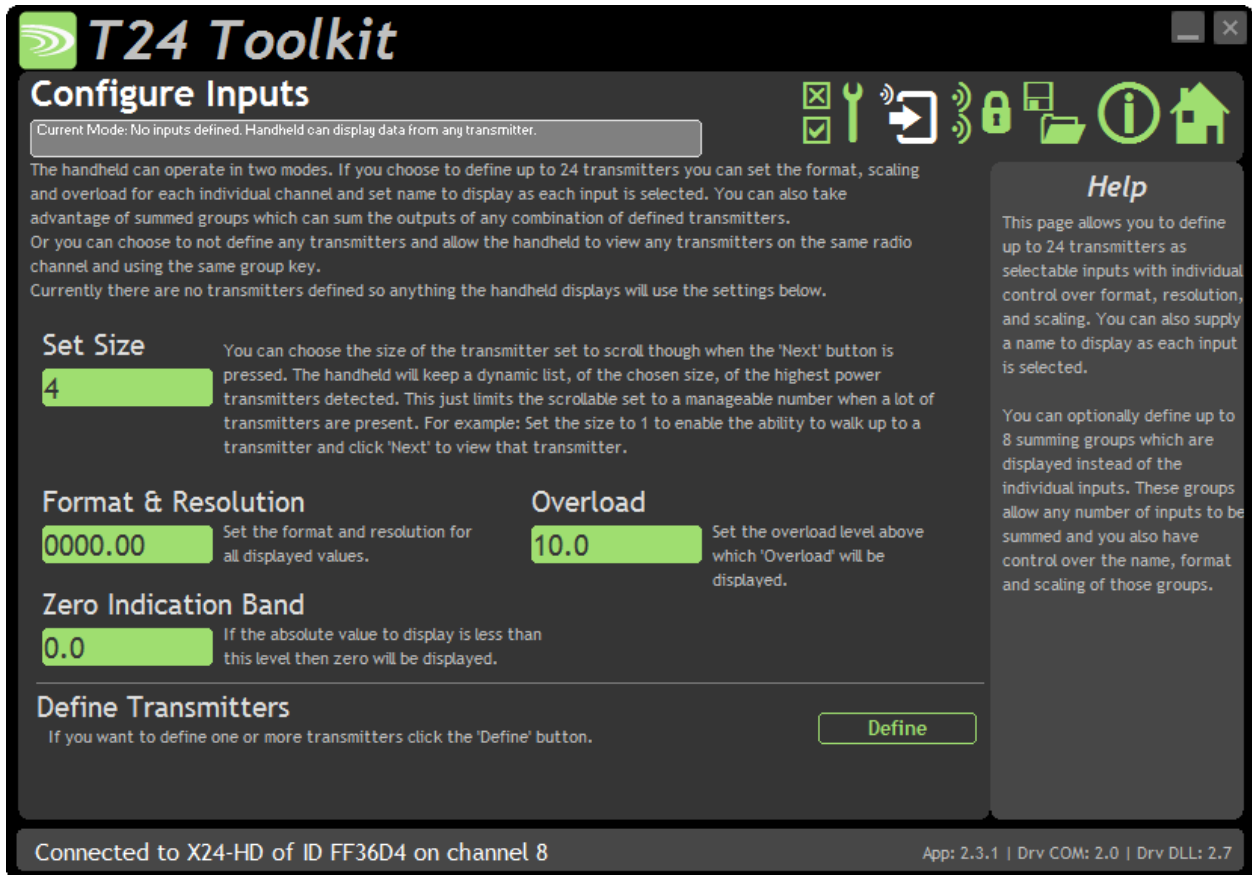

Here you can adjust the settings common to all displayed transmitter values.

Items you can change:

- Set Size** This setting determines how many transmitter modules, with the highest signal levels, make up the set through which the Next key cycles. Based on the application and how many transmitter modules are in the vicinity of the handheld this list size can affect how the operator uses the handheld. See [Example Configuration Scenarios](#)
- Format & Resolution** Here you can define how the values are displayed on the LCD. There are 7 digits available and you can define where the decimal point is shown by entering numerals where a zero indicates a numeric digit position. When the data is being displayed the number of decimal places you define may be overridden as the display will always show the correct number of integer digits. Example: If you set the format to 000.0000 and the value to display is 1000.1234 the display will show 1000.123
- You can also define the resolution, which is the block size of changes to the display. Example: If you enter the format as 000.0005 the display will only change in steps of 0.0005 which can be used to mask noisy digits at high resolutions.

Zero Indication Band	<p>Using this setting you can mask tiny changes in input after you press the Tare button. Entering zero will disable this function. Entering a non-zero value will provide a band within which the display will always read zero. Once the reading exceeds this value the real weight will be displayed as no taring is taking place.</p> <p>Example: You are adding boxes to a platform and you press tare between adding each one so you can see the weight of each box. Without this setting activated each time you tare the display will be around zero but not exactly zero (By setting the display resolution you may also hide this difference) by setting a small value here such as 0.2kg the display will show a stable zero while actual weight is fluctuating less than $\pm 0.2\text{kg}$.</p>
Overload	<p>You can enter a limit here above which 'Overload' will be shown on the display instead of the actual value. Applies to the gross input value including any custom scaling. Enter zero to disable this feature.</p>
Define Transmitters	<p>Click the 'Define' button to display the page that allows you to define Transmitters.</p>

Defined Transmitters

These pages will be displayed when at least one Transmitter has been defined or you click the 'Define' button on the page shown when no transmitters are defined (See previous page).

General Tab

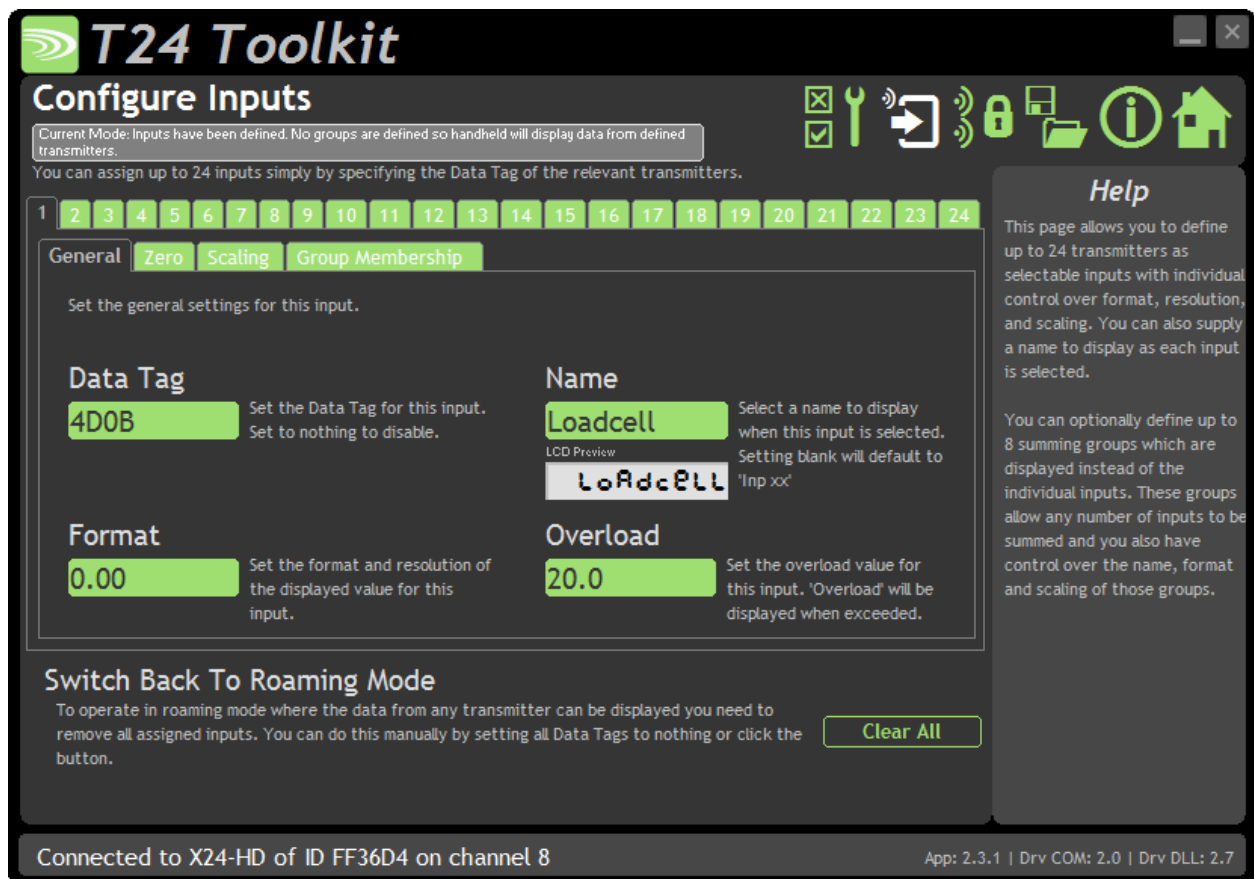

Here you can adjust the general settings for the selected Transmitter input. Select the required input by clicking the numbered tabs along the top of the page.

Items you can change:

- Data Tag** By entering a Data Tag you enable this Transmitter Input. Enter zero to disable this input. You can enter Data Tags in any of the 24 available slots. The Next button will just cycle between those entered.
- Name** As you cycle between available transmitters with the Next key an identifier is shown briefly before the value is displayed. If you enter text here then this will be shown but if you leave this blank the Data Tag will be shown. Some letters cannot be displayed on a 7 segment LCD digit. You cannot use letters M, W or K. Some letters will look alike. i.e. Z and 2. The LCD Preview will show how the entered name will look on the display.

Format	<p>Here you can define how the values are displayed on the LCD. There are 7 digits available and you can define where the decimal point is shown by entering numerals where a zero indicates a numeric digit position.</p> <p>When the data is being displayed the number of decimal places you define may be overridden as the display will always show the correct number of integer digits.</p> <p>Example: If you set the format to 000.0000 and the value to display is 1000.1234 the display will show 1000.123</p> <p>You can also define the resolution, which is the block size of changes to the display.</p> <p>Example: If you enter the format as 000.0005 the display will only change in steps of 0.0005 which can be used to mask noisy digits at high resolutions.</p>
Overload Limit	<p>You can enter a limit here above which 'Overload' will be shown on the display instead of the actual value. Applies to the gross input value including any custom scaling.</p> <p>Enter zero to disable this feature.</p>
Switch Back to Roaming Mode	<p>Click the 'Clear All' button to remove all of the transmitters and group settings to return to the roaming mode with no transmitters defined.</p>



The changes you make are not saved to the handheld until you click on a new input tab or select another page to view.

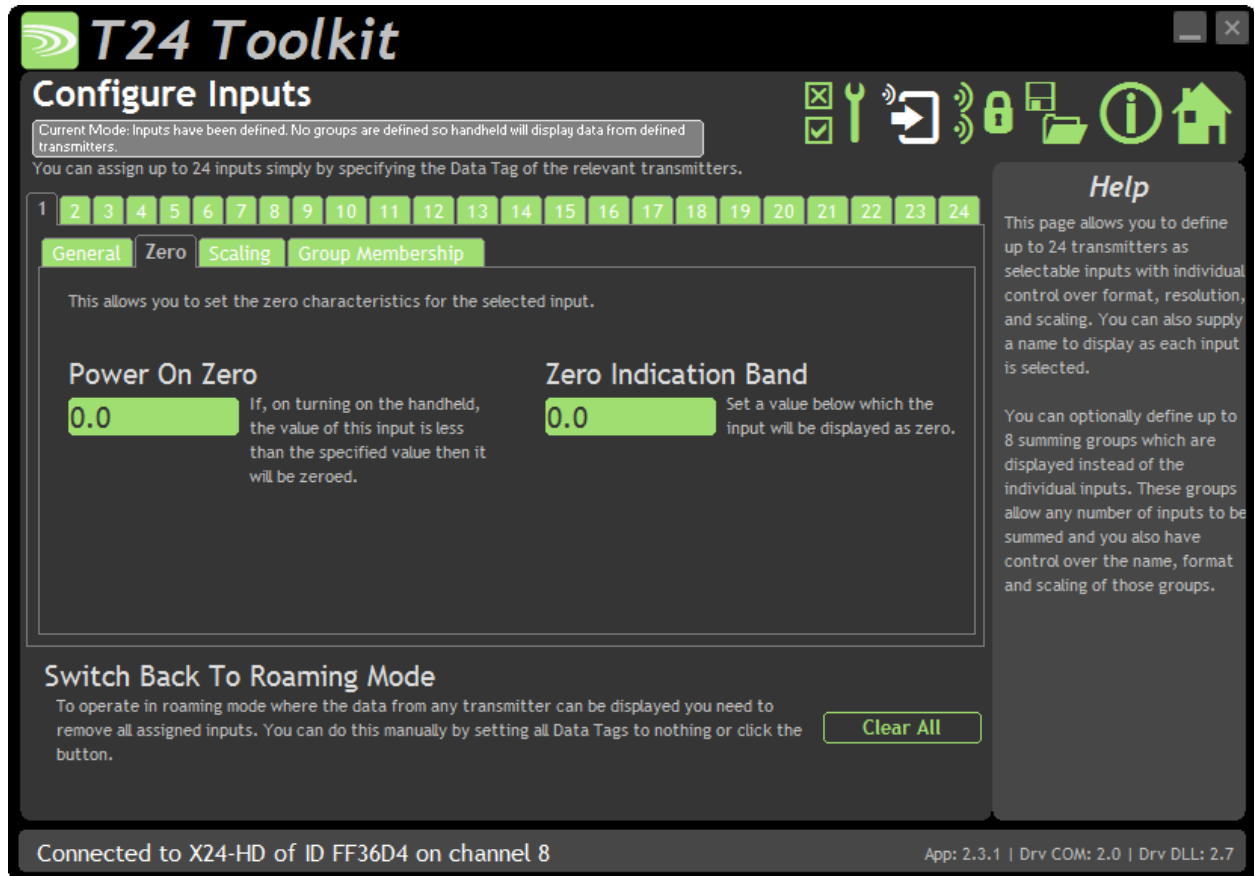

Here you can configure the zero settings for the selected Transmitter input.

Items you can change:

Power On Zero Here you can determine whether the X24-HD performs automatic zero when it is powered on. Enter zero to disable this function. If you enter a non-zero value then when the handheld is first turned on it checks the value read from the transmitter module. If this falls within \pm of this value then the display will be altered so this reads zero.

Example: A strain gauge transmitter module (X24-SA) is calibrated in kg and measures the weight of boxes on a platform. The weight of the platform itself has been removed using system zero on the transmitter module. Sometimes there is debris on the platform which you do not want to see when viewing the weight of boxes that will be placed on the platform later. The minimum weight of a box is 5 kg so you could set the Power On Auto Zero to 2 kg. When you turn on the handheld, if the weight on the platform is between -2 and +2kg then the handheld will tare this weight off and so read zero.

Zero Indication Band Using this setting you can mask tiny changes in input after you press the Tare button or are close to zero in gross mode.
Entering zero will disable this function.
Entering a non-zero value will provide a band within which the display will always read zero.
Once the reading exceeds this value the real weight will be displayed as no taring is taking place.

Example: You are adding boxes to a platform and you press tare between adding each one so you can see the weight of each box.
Without this setting activated each time you tare the display will be around zero but not exactly zero (By setting the display resolution you may also hide this difference) by setting a small value here such as 0.2kg the display will show a stable zero while actual weight is fluctuating less than $\pm 0.2\text{kg}$.

Switch Back to Click the 'Clear All' button to remove **all** of the transmitters and group settings to return
Roaming Mode to the roaming mode with no transmitters defined.

 *The changes you make are not saved to the handheld until you click on a new input tab or select another page to view.*

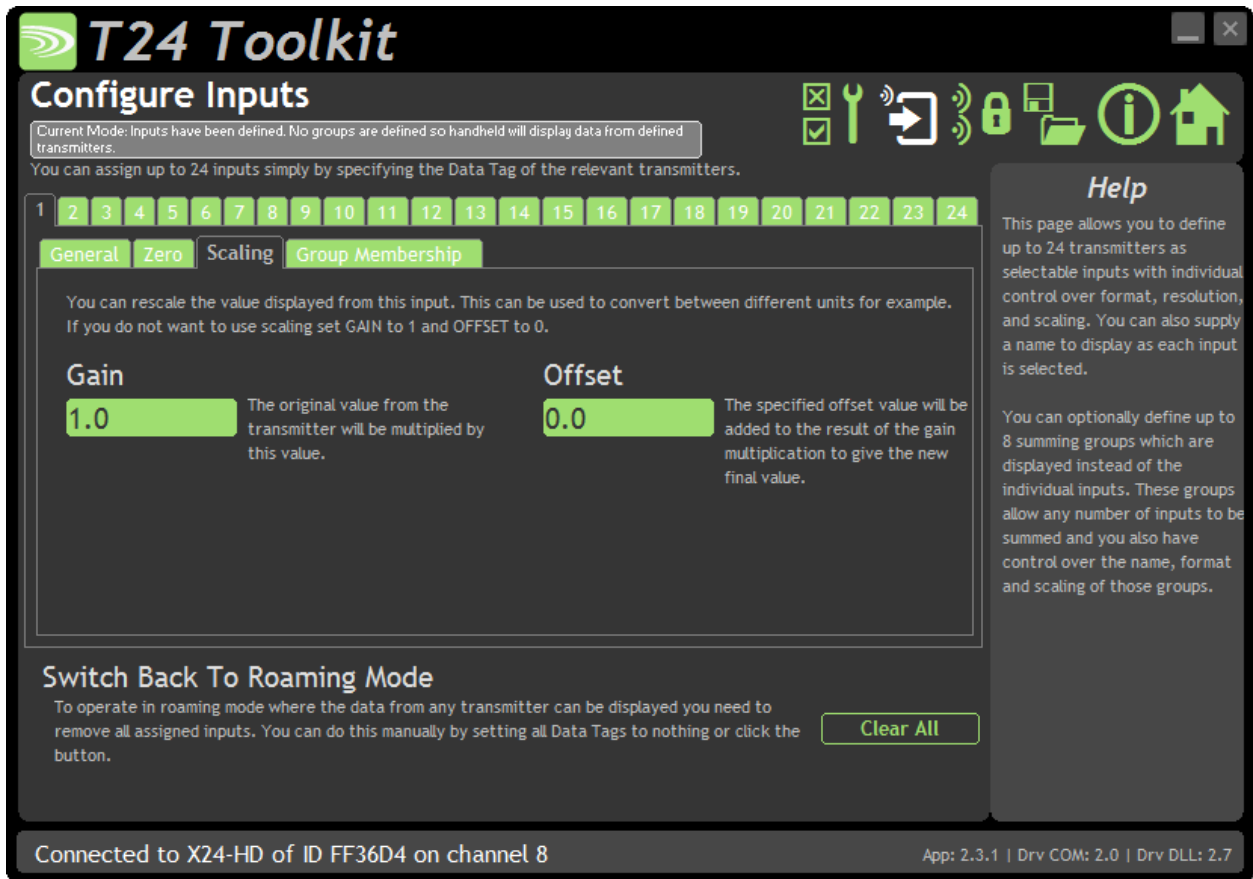

Here you can configure the scaling for the selected Transmitter input.

Use the Gain and Offset to manipulate the input value. This can perform quite a few useful functions such as:

Zero an Input – If a particular Transmitter value has a value that you want to remove but do not want to perform a system zero at the transmitter end you can use the Offset to remove that value. Setting the Offset to 10 will remove 10 from the transmitted value.

Convert Units – If the transmitter was calibrated in kg and you wish to display the value in lbs you can set a Gain of 2.20462 and an Offset of 0.0

Change Polarity – If the Transmitted value was negative but you wanted to display a positive value set the Gain to -1.0 and the Offset to 0.0



$$\text{Actual Displayed Value} = \text{Transmitted Value} * \text{Gain} - \text{Offset}$$

Items you can change:

- Gain This value will be multiplied by the transmitted value to provide the actual displayed value. The default is 1.0

- Offset This offset will be applied to the transmitted value (After gain is applied) to provide the actual displayed value. The default is 0.0

- Switch Back to Roaming Mode Click the 'Clear All' button to remove **all** of the transmitters and group settings to return to the roaming mode with no transmitters defined.

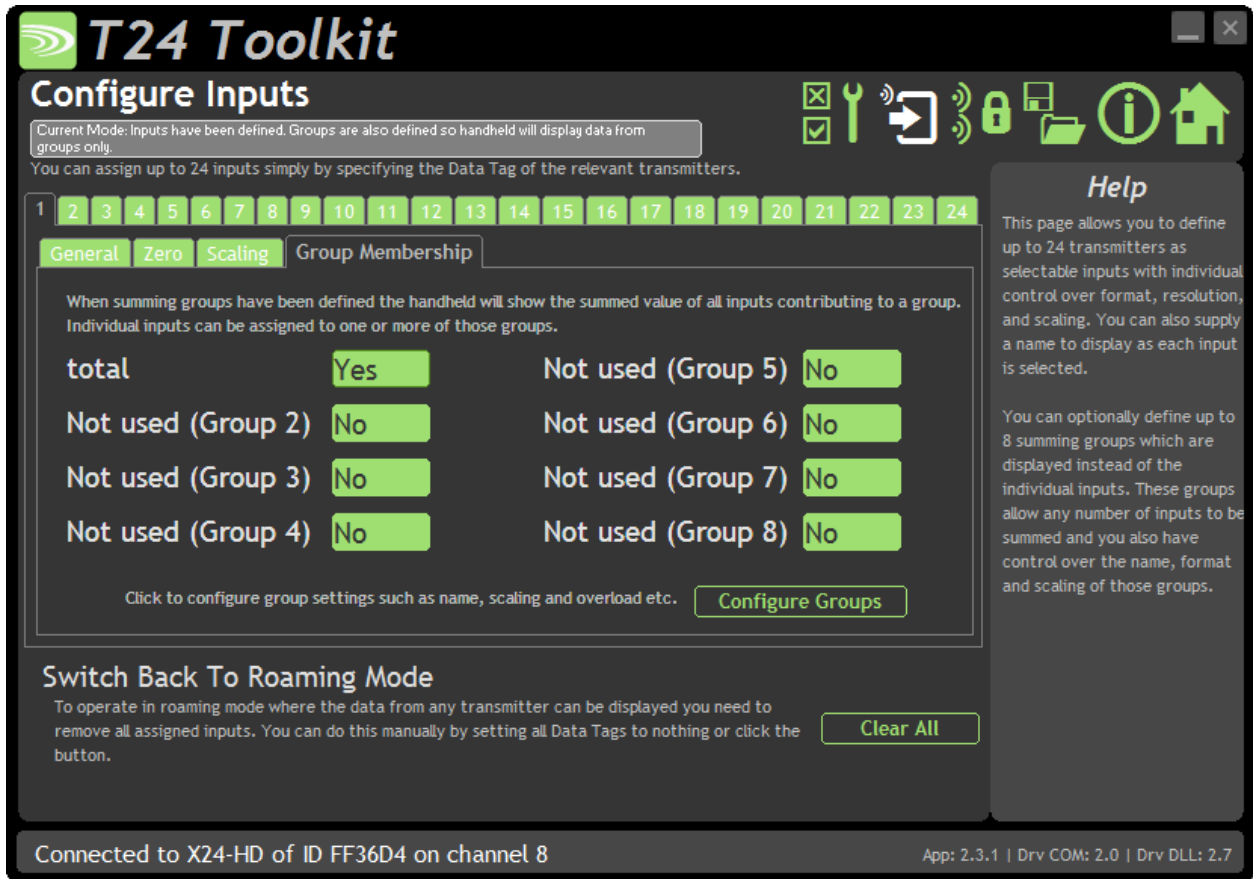

Here you can assign the selected Transmitter input to belong to any of the Summing Groups.

Items you can change:

- 8 Available Summing Groups The 8 available Summing Groups are shown here regardless of whether a group has been defined or not. Simply select Yes or No to indicate whether this Transmitter Input will contribute to that group’s total value.
- Configure Groups Button Clicking this button will open the [Summing Groups](#) page.
- Switch Back to Roaming Mode Click the ‘Clear All’ button to remove **all** of the transmitters and group settings to return to the roaming mode with no transmitters defined.

i *The changes you make are not saved to the handheld until you click on a new input tab or select another page to view.*

Summing Groups

General Tab

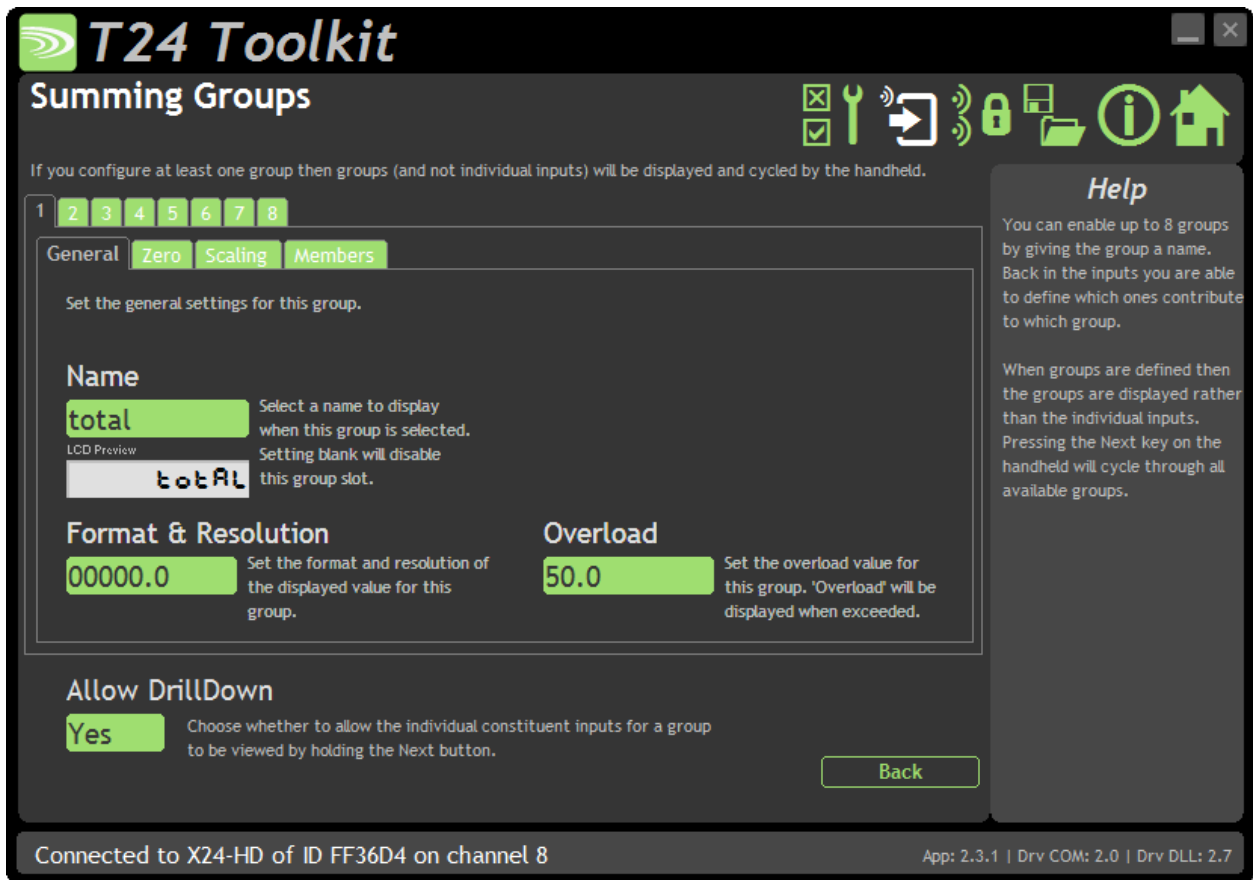

Here you can configure general settings for the selected Summing Group. Select the group by clicking the numbered tabs along the top of the page.



As soon as at least one Summing Group has been enabled (By naming it) then the handheld will only cycle through the Summing Groups instead of the individual inputs. The values shown will be the sum of all the individual inputs that are members of that group.

Items you can change:

Name Summing Groups are enabled by giving them a name. Leave the name blank to disable the selected group. As you cycle between group totals with the Next key an identifier is shown briefly before the total is displayed. Some letters cannot be displayed on a 7 segment LCD digit. You cannot use letters M, W or K. Some letters will look alike. i.e. Z and 2. The LCD Preview will show how the entered name will look on the display.

Format & Resolution	<p>Here you can define how the values are displayed on the LCD. There are 7 digits available and you can define where the decimal point is shown by entering numerals where a zero indicates a numeric digit position.</p> <p>When the data is being displayed the number of decimal places you define may be overridden as the display will always show the correct number of integer digits.</p> <p>Example: If you set the format to 000.0000 and the value to display is 1000.1234 the display will show 1000.123</p> <p>You can also define the resolution, which is the block size of changes to the display.</p> <p>Example: If you enter the format as 000.0005 the display will only change in steps of 0.0005 which can be used to mask noisy digits at high resolutions.</p>
Overload	<p>You can enter a limit here above which 'Overload' will be shown on the display instead of the actual value. Applies to the gross input value including any custom scaling.</p> <p>Enter zero to disable this feature.</p>
Allow Drilldown	<p>When at least one Summing Group has been named the Next key will cycle through group totals rather than individual inputs.</p> <p>If you allow drilldown then holding the Next key for a long press will start to display the individual inputs that are members of the group. Each press of the Next key will show the next input in the group. After the last input has been shown the display will revert back to displaying the groups again.</p>
Back Button	<p>Click the 'Back' button to display the Transmitter Inputs pages again.</p>



The changes you make are not saved to the handheld until you click on a new input tab or select another page to view.



Here you can adjust the zero of the selected summing group.

Items you can change:

- | | |
|----------------------|--|
| Zero Indication Band | <p>Using this setting you can mask tiny changes in input after you press the Tare button. Entering zero will disable this function. Entering a non-zero value will provide a band within which the display will always read zero. Once the reading exceeds this value the real weight will be displayed as no taring is taking place.</p> <p>Example: You are adding boxes to a platform and you press tare between adding each one so you can see the weight of each box. Without this setting activated each time you tare the display will be around zero but not exactly zero (By setting the display resolution you may also hide this difference) by setting a small value here such as 0.2kg the display will show a stable zero while actual weight is fluctuating less than $\pm 0.2\text{kg}$.</p> |
| Allow Drilldown | <p>When at least one Summing Group has been named the Next key will cycle through group totals rather than individual inputs. If you allow drilldown then holding the Next key for a long press will start to display the individual inputs that are members of the group. Each press of the Next key will show the next input in the group. After the last input has been shown the display will revert back to displaying the groups again.</p> |
| Back Button | <p>Click the 'Back' button to display the Transmitter Inputs pages again.</p> |

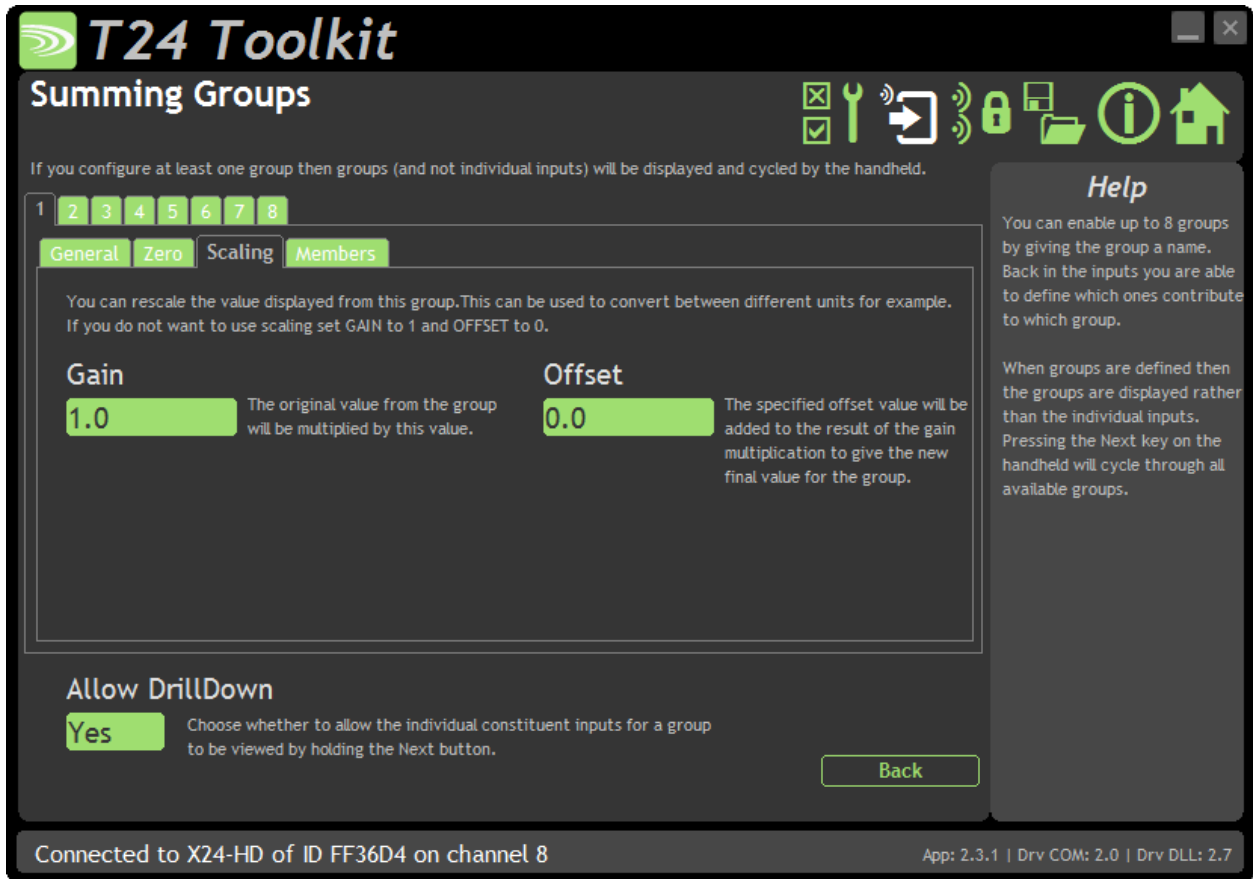

Here you can configure the scaling for the selected Summing Group.

Use the Gain and Offset to manipulate the summing groups value. This can perform quite a few useful functions such as:

- Zero a Sum** – If the sum of the Transmitters have has a value that you want to remove but do not want to perform a system zero at each of the transmitters you can use the Offset to remove that value. Setting the Offset to 10 will remove 10 from the sum for example.
- Convert Units** – If the transmitters were calibrated in kg and you wish to display the sum in lbs you can set a Gain of 2.20462 and an Offset of 0.0
- Change Polarity** – If the sum value is negative but you want to display a positive value set the Gain to -1.0 and the Offset to 0.0

i Actual Displayed Value = Transmitted Values Sum * Gain - Offset

Items you can change:

- Gain This value will be multiplied by the transmitted sum value to provide the actual displayed value. The default is 1.0
- Offset This offset will be applied to the transmitted sum value (After gain is applied) to provide the actual displayed value. The default is 0.0

- Allow Drilldown When at least one Summing Group has been named the Next key will cycle through group totals rather than individual inputs. If you allow drilldown then holding the Next key for a long press will start to display the individual inputs that are members of the group. Each press of the Next key will show the next input in the group. After the last input has been shown the display will revert back to displaying the groups again.
- Back Button Click the 'Back' button to display the Transmitter Inputs pages again.

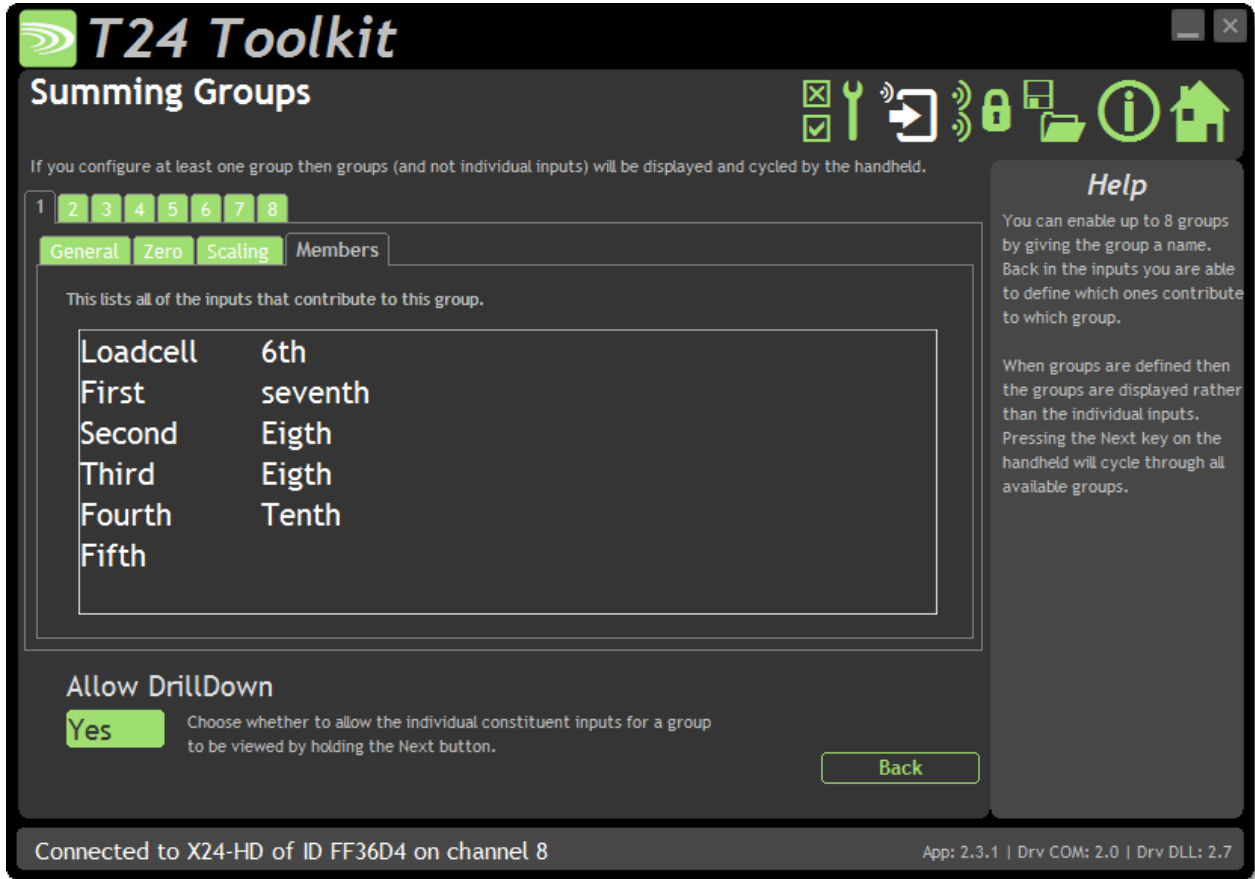

Here you can see a list of inputs that are members of the selected Summing Group and whose transmitted values are summed to create the value displayed by the group. The list will display the name of the input or the Data Tag if no name is assigned.

Items you can change:

Allow Drilldown When at least one Summing Group has been enabled, by entering a Name, the Next key will cycle through the Summing Group totals rather than individual inputs. If you allow drilldown then holding the Next key for a long press will start to display the individual inputs that are members of the group. Each press of the Next key will show the next input in the group. After the last input has been shown the display will revert back to displaying the groups again.

Back Button Click the 'Back' button to display the Transmitter Inputs pages again.

Example Configuration Scenarios

Examples Using No Defined Transmitter List (Roaming Mode)

The following two examples show scenarios where it would be impractical to define each available transmitter because either there are more than 24 transmitters or the transmitters available may change and re-configuration of the handheld is undesirable.

So for these examples the handheld has no Transmitter Inputs defined and therefore operates in 'Roaming' mode where it can display the value from any transmitter on the same radio channel and Group Key. In both cases the Sleep Delays of the Transmitters are set to 30 seconds as in this mode the handheld will wake the Transmitters but not send them to sleep.

Long Bridge

A 1000m bridge has transmitters placed along its length at 10m intervals. Periodically an operator must record the values from each of these transmitters. By choosing a Set Size of 10 the operator can start at one end of the bridge and click the next key to cycle around the ten nearest Transmitters. Once the operator starts to see transmitters already seen he can walk further up the bridge to cycle around a new set of 10. As the operator moves along the bridge and comes into range of Transmitters they are woken automatically by the handheld. As the handheld moves out of range of a transmitter it will return to sleep because of its Sleep Delay.

Brewery

A chemical company has a large storage room filled with barrels sitting on weigh scales containing Transmitters. Each Transmitter has its LED visible so when the handheld is displaying the value from a particular barrel the operator has visual feedback of the selected barrel. Because the operator needs to put a sticker on those barrels that are less than a certain weight he needs to approach each barrel individually. By using a Set Size of 1 on the handheld, each press of the Next key will effectively select the Transmitter with the highest transmission signal level so as the operator approaches each barrel and presses the Next key he would see the LED light on the nearest barrel's Transmitter LED and therefore know he was looking at the weight for the correct barrel without having to pay attention to the displayed Data Tag.

Example of Defined Transmitter List

Single Transmitter

The Data Tag of a Transmitter connected to a guy line is defined as the only input. Now when the handheld is turned on the Transmitter is woken and the operator can read the tension in the guy line. On turning off the handheld the Transmitter is sent to sleep to conserve its battery.

Multiple Transmitters

Three cranes are monitored by a single handheld so the Transmitter on each crane is defined in the Transmitter Input list. Inputs are named as **Crane 1**, **Crane 2** and **Crane 3** so as the operator clicks the Next key he can see which crane he is monitoring. A long press on the Next key verifies the currently viewed crane name without moving on to the next one.

Example of Summing Groups

Alternative Units

A material vessel sits on two loadcells and the operator wants to view the total load in both tonnes and lbs. The loadcells are calibrated in lbs.

First each Transmitter is added to the defined list of inputs by entering its Data Tag.

Next a Summing Group is defined with a name of **lbs** and both inputs are assigned as members of this group.

Another Summing Group is defined with the name **tonnes** and both inputs are assigned as members of this group as well.

To achieve the unit conversion the scaling of the **lbs** group is configured to convert lbs to tonnes so the **Gain** is set to 0.000453592

Now when the handheld is turned on both Transmitters are woken and the sum in **lbs** is displayed. By clicking the Next key the operator can switch between displaying **lbs** and **tonnes**. A long press of the Next key will display the name of the group and hence the units currently being displayed.

Grouping Sums

A suspended truss gantry has a loadcell and transmitter fitted to each corner and the handheld is used to monitor various aspects of its loading.



The operator wants to know total weight and also how the gantry is balanced so the handheld is going to display Summing Groups

First we would assign the four Transmitters to the inputs by defining their Data Tags.



The inputs are named as follows:

- 1 Rear L
- 2 Rear R
- 3 Front L
- 4 Front R

If we did not assign Summing Groups at this point then the handheld would just cycle around these four inputs as the Next key is pressed.

However, we would like to know the total weight and also see how the gantry is balanced left to right and also front to rear so we will add five Summing Groups as follows.

- Assign the name **Total** to Summing Group 1
- Assign the name **Rear** to Summing Group 2
- Assign the name **Front** to Summing Group 3
- Assign the name **Left** to Summing Group 4
- Assign the name **Right** to Summing Group 5

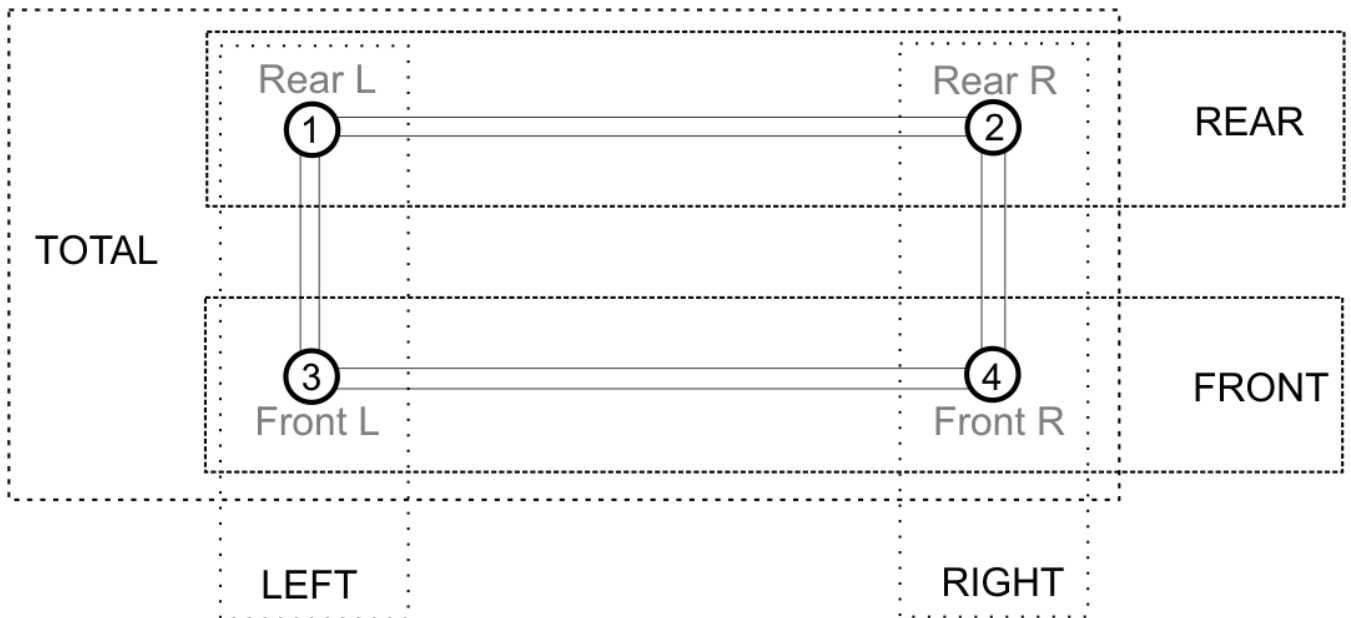

Now we need to assign the appropriate input to membership of the groups. So by going back to look at each defined input we simply assign the following inputs to each group.

Input 1 **Rear L** is assigned to group **Total, Rear** and **Left**

Input 2 **Rear R** is assigned to group **Total, Rear** and **Right**

Input 3 **Front L** is assigned to group **Total, Front** and **Left**

Input 4 **Front R** is assigned to group **Total, Front** and **Right**

Now when the handheld is turned on it will be displaying group **Total** and the operator will see the total weight of the gantry. Pressing the Next key will then display **Rear, Front, Left** then **Right** totals before cycling back to displaying the **Total**.

If we allowed Drilling Down then a long press while viewing any of the group totals will allow the constituent inputs to be viewed one after another before returning to the groups again.

Enclosure & Mounting

See [Appendix A – Handheld Style](#) section for more information.

Antennas

These modules have the antenna already fitted inside the enclosure so there are no specific mounting requirements.

Specification

Electrical	Min	Typical	Max	Units
Power Supply voltage	2.3	3.0	3.6	Vdc

Power Supply	Min	Typical	Max	Units
Active		40	55	mA
Low power mode		5	20	µA
Estimated Battery life using Energizer L91 AA batteries:				
Standby mode (Powered off)		>5		Years
Continuous operation		54		Hours

Environmental	Min	Typical	Max	Units
IP rating		IP67		
Operating Temperature Range	-10		+50	C
Storage Temperature	-40		+85	C
Humidity	0		95	%RH

Physical	
Hand Held Dimensions	90 mm x 152 mm x 34 mm

Radio Range

To determine radio range please refer to [Appendix B – Antenna Range](#)

Appendices

Appendix A - Enclosures

OEM Transmitter Modules

Dimensions

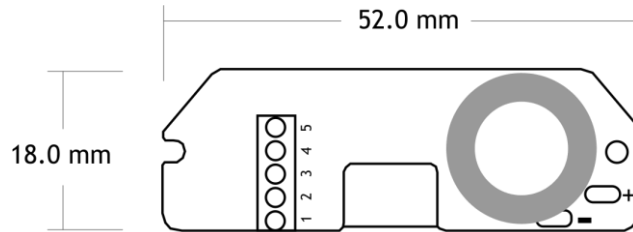

Height is 17 mm

Opening the Case

These modules are not housed in an enclosure.

Mounting Information

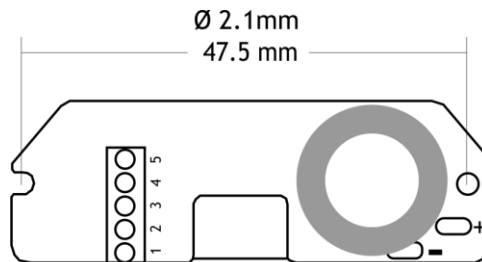

There are two holes available for mounting and can accept an M2 screw or American equivalent #0-80.

! DO NOT USE #2 screw size.

Note that the mounting hole is connected directly to the Battery ground of the transmitter module. The mounting hole near the chip antenna cannot accept metal mounting hardware.

Antenna Position

Modules that use an external antenna can be mounted anywhere but the mounting of the antenna will have restrictions. See the appropriate section in [Appendix B - Antennas](#)

Environmental Protection

These modules are not protected against the environment.

ACMi Type



Dimensions

This enclosure is 76.6 mm X 59 mm and 31 mm deep. The gland extends a further 25 mm from one long side.

Opening the Case

The case lid is secured with 4 x #2 cross head screws, remove the four screws and lift lid.

Mounting Information

The enclosure has two mounting holes as shown below; these mounting holes are external to the seal but still covered by the case lid to offer fixings for some environmental protection. In addition mountings can be made through the back of the case however a seal or gasket must be used to maintain environmental protection.

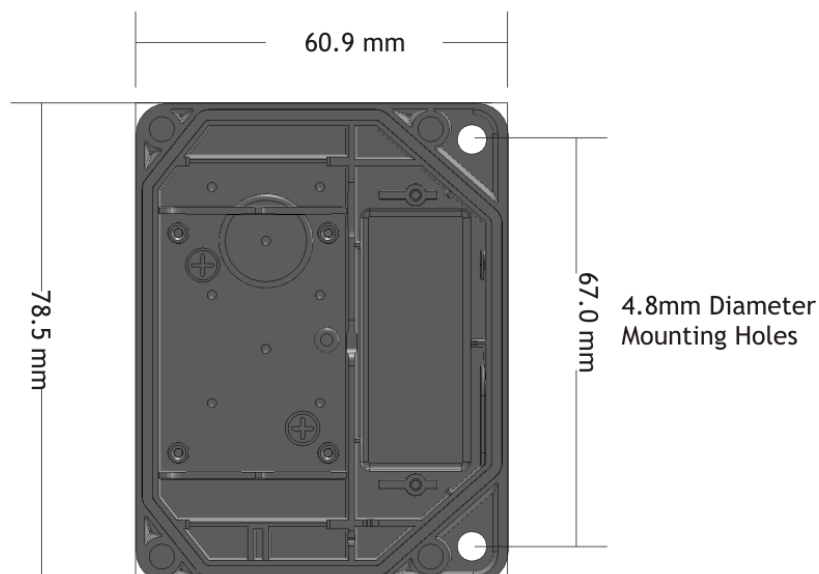



The antenna feeder cable and load cell connection cable must not be routed over, or near, the cross hatched area on the antenna shown below as this will affect range.



Antenna Position

This enclosure is fitted with a T24-ANTA antenna which sits over the wiring access chamber and is covered by the enclosure lid.

Environmental Protection

The case is environmentally sealed to IP67 when the correct cable diameters are used.

The sealing gasket resides in the base. Be careful when replacing the lid that there are no dirt particles on the gasket channel or lid as this may reduce the sealing capability.

The cable diameter can range from 3.0 mm to 6.5 mm. Cables of a smaller diameter may be used if sleeved to increase their diameter.

When mounting the enclosure outside the cables should be dressed to provide a drip loop.

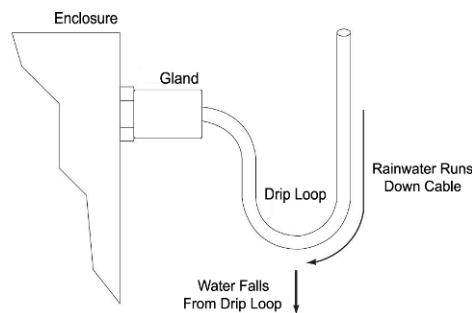

Handheld Type



Dimensions

This ABS handheld case is 152 mm X 90 mm and 34 mm deep at its highest section.

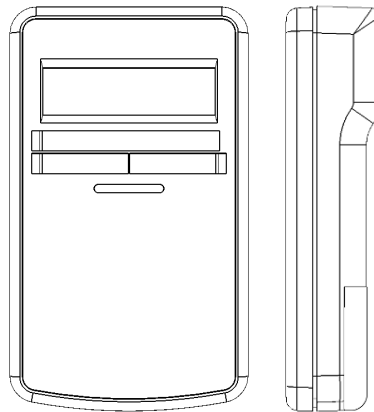

Opening the Case

The battery compartment is secured with two Philips head screws.

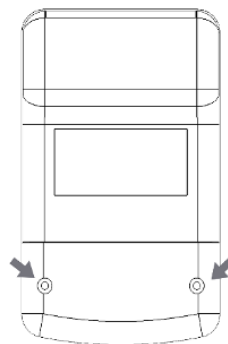

Once the battery compartment has been removed this gives access to two further screws which can be removed (along with the two at the top end) to allow the entire case to come apart. This gives access to the legend channels where cardboard legends can be slipped in behind the transparent label windows where supported. Note that the top two screws will have rubber 'O' rings on them. These rings are an integral part of the sealing mechanism.



The battery compartment cannot be opened in the hazardous area!

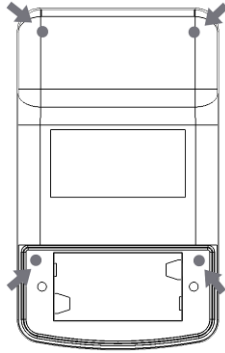

When the case comes apart be careful of any wires running between the two case halves.

Mounting Information

There are no mounting options on the handheld enclosure.

Antenna Position

The enclosure is fitted with a T24-ANTA antenna which is mounted in the top end of the enclosure.

Environmental Protection

The enclosure is sealed to IP67. Ensure gaskets and mating parts are free from dirt and debris when re-assembling.

Appendix B - Antennas

Overview

Radio performance at microwave wavelengths is very dependent upon the operating environment; any structure within the operating region of the radios will give rise to three effects:

Obscuration. Obscuration will result in reduced range and occurs when an obstruction masks the line-of-sight between radios.

Aberrations to the horizontal and vertical space patterns. Distortion of these patterns may occur if structures or objects are placed in the near or intermediate field of the antenna. The effect will be to distort the coverage patterns, adversely affecting range and link quality.

Reflection. Any object placed in line-of-sight of the transmit antenna will result in signals arriving at the receiver by an indirect path. Degradation of performance due to reflection (multipath effects) appears as reduced range or poor link quality.

Any of the above will reduce RSSI figures, an increase in the packet loss rate and in extreme cases complete loss of signal. Fortunately, if consideration is given to these effects at the integration stage then a good quality link will be obtained.

Guidelines for product design:

If the application demands that the radio is fitted inside a metal enclosure then ensure that the specified clearances are maintained around the antenna and design in an RF window at least as large as the clearance dimensions specified below but ideally as large as possible.

RA24i radios fitted inside a product should be oriented so that the chip antenna will be vertical when the product is in its normal operating position.



Enclosures must meet the requirements specified in the Schedule Of Limitations

Guidelines for installation:

When planning installations ensure that line-of-sight between nodes is maintained and that objects or structures are kept at least one metre away from antennae wherever possible.

To avoid poor link quality between a RA24i radio and a handheld module ensure that the RA24i is mounted so that the chip antenna is vertical. Improvement may also be obtained by altering the height above ground of the RA24i; a small increase or reduction in antenna elevation will often improve reception.

Range underwater is only 100 mm or so depending on packet rate. Best performance underwater is obtained by using low packet rates and immersing water-proofed antennae rather than water-tight enclosures containing the antennae.

T24-ANTA

This antenna is designed to be attached to a flat surface inside product enclosures made from plastic or fibre-glass. It is intended to be directly connected to the radio module.



Mounting

Products containing this type of antenna should be oriented so that the antenna long axis is vertical during normal operation if possible. Antenna feeder cable should be arranged to lie along the ground plane section, allowing the feeder to run close to the active element will adversely affect performance. 60 mm UFL cable included.

The PCB requires 3.0 mm clearance on all edges, this also applies to the RF window.

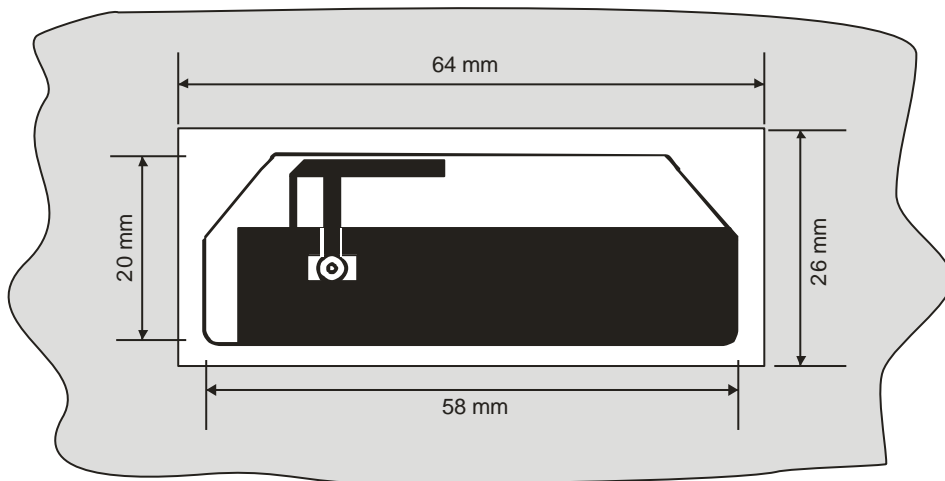

The antenna feeder cable, or any other cables or wires, must not be routed over or near the cross hatched area shown below as this will affect range.

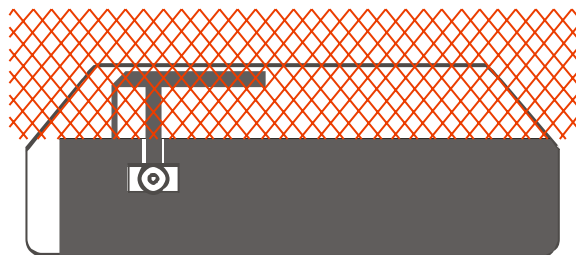

Specification



Gain: 3.0dBi

Type: Inverted F Printed circuit antenna





Connection: 60 mm cable with UFL connector

Antenna Range

The following tables give the maximum range in an open field site between two T24 modules. Look up the T24 module to determine antenna type.

Integrated Antenna 	T24-BSu
T24-ANTA 	T24-BSue, T24-BS, X24-HD, X24-SAe X24-ACMi-xx (Any transmitter module housed in the ACMi enclosure)

Then refer to the table below to find the achievable range between two antenna types.

		Integrated Antenna 	T24-ANTA 
Integrated Antenna 		500m	600m
T24-ANTA 		600m	800m

Tests conducted in an open field site with the transmitter at the top of a 3m pole. The receiver was mounted 1.5m off the ground.

Appendix C - Radio Specification

The following specification applies to all T24 modules.

	Min	Typical	Max	Units
License		License Exempt		
Modulation method		MS (QPSK)		
Radio type		Transceiver (2 way)		
Data rate		250		k bits/sec
Radio Frequency	2.4000		2.4835	GHz
Power		10		mW
Channels (DSSS)		15		

For radio range information See [Appendix B – Antenna Range](#)

Appendix D – CE, FCC and IC Approval Statements

CE



Complies with EMC directive. 2014/30/EU
The Radio Equipment Directive, 2014/53/EU,

European Community, Switzerland, Norway, Iceland, and Liechtenstein

- English: This equipment is in compliance with the essential requirements and other relevant provisions of Directive 2014/53/EU.
- Deutsch: Dieses Gerät entspricht den grundlegenden Anforderungen und den weiteren entsprechenden Vorgaben der Richtlinie 2014/53/EU.
- Dansk: Dette udstyr er i overensstemmelse med de væsentlige krav og andre relevante bestemmelser i Direktiv 2014/53/EU.
- Español: Este equipo cumple con los requisitos esenciales así como con otras disposiciones de la Directiva 2014/53/EU.
- Français: Cet appareil est conforme aux exigences essentielles et aux autres dispositions pertinentes de la Directive 2014/53/EU.
- Íslenska: Þessi búnaður samrýmist lögboðnum kröfum og öðrum ákvæðum tilskipunar 2014/53/EU.
- Italiano: Questo apparato é conforme ai requisiti essenziali ed agli altri principi sanciti dalla Direttiva 2014/53/EU.
- Nederlands: Deze apparatuur voldoet aan de belangrijkste eisen en andere voorzieningen van richtlijn 2014/53/EU.
- Norsk: Dette utstyret er i samsvar med de grunnleggende krav og andre relevante bestemmelser i EU-direktiv 2014/53/EU.
- Português: Este equipamento satisfaz os requisitos essenciais e outras provisões da Directiva 2014/53/EU.
- Suomalainen: Tämä laite täyttää direktiivin 2014/53/EU oleelliset vaatimukset ja on siinä asetettujen muidenkin ehtojen mukainen.
- Svenska: Denna utrustning är i överensstämmelse med de väsentliga kraven och andra relevanta bestämmelser i Direktiv 2014/53/EU.

Manufactured in the UK by: Mantracourt Electronics Ltd, The Drive, Farringdon, Exeter, Devon, EX5 2JB, UK



IC:7224A-RA24

This device complies with Industry Canada licence-exempt RSS standard(s). Operation is subject to the following two conditions: (1) this device may not cause interference, and (2) this device must accept any interference, including interference that may cause undesired operation of the device.

Under Industry Canada regulations, this radio transmitter may only operate using an antenna of a type and maximum (or lesser) gain approved for the transmitter by Industry Canada. To reduce potential radio interference to other users, the antenna type and its gain should be so chosen that the equivalent isotropically radiated power (e.i.r.p.) is not more than that necessary for successful communication.

This radio transmitter RA24 has been approved by Industry Canada to operate with the antenna types listed below with the maximum permissible gain and required antenna impedance for each antenna type indicated. Antenna types not included in this list, having a gain greater than the maximum gain indicated for that type, are strictly prohibited for use with this device.

Antenna	Gain (dBi)	Antenna Type	Manufacturer/Vendor
Ant A	3	Inverted F	Mantracourt
Ant C	2.2	½ wave Dipole	Mantracourt
Integrated	1.3	Chip antenna	Mantracourt

To comply with Industry Canada RF radiation exposure limits for general population, the antenna(s) used for this transmitter must be installed such that a minimum separation distance of 5 cm is maintained between the radiator (antenna) and all persons at all times and must not be co-located or operating in conjunction with any other antenna or transmitter.

Manufactured in the UK by: Mantracourt Electronics Ltd, The Drive, Farringdon, Exeter, Devon, EX5 2JB, UK



Family: RA24
Models: i and e

FCC ID: VHARA24

- This device complies with Part 15 of the FCC Rules. Operation is subject to the following two conditions:
(1) This device may not cause harmful interference, and
(2) This device must accept any interference received, including interference that may cause undesired operation.
- This equipment complies with FCC radiation exposure limits set forth for an uncontrolled environment. End users must follow the specific operating instructions for satisfying RF exposure compliance. This transmitter must not be co-located or operating in conjunction with any other antenna or transmitter.
- Changes or modifications not expressly approved by the party responsible for compliance could void the user's authority to operate the equipment

For use with antennas: integrated, T24-ANTA, T24-ANTB, T24-ANTC, T24-ANTD, T24-ANTE antennas and those listed in the table below.

Manufacturer Code	Description	Gain	Available From
DELTA7A	Dual band 2.4 or 5.8GHz Hinged mount whip	2.1dBi	Sequoia
DELTA14	Stubby WiFi / WLAN Antenna	2.0dBi	Sequoia
DELTA15/SMAM/RA/RP11	2.4GHz Right angle RPSMA	2.0dBi	Sequoia
1699481	AUREL ANT.RP SMA 2.4GHz	2.0dBi	Farnell Electronic Components
537-785	EAD, FBKR35068-RS-KR WiFi Antenna	2.0dBi	RS Components

Manufactured in the UK by: Mantracourt Electronics Ltd, The Drive, Farringdon, Exeter, Devon, EX5 2JB, UK

Appendix E - OEM / Reseller Marking and Documentation Requirements

CE

The T24 series has been certified for several European countries.

If the transmitter module is incorporated into a product, the manufacturer must ensure compliance of the final product to the European harmonized EMC and low-voltage/safety standards. A Declaration of Conformity must be issued for each of these standards and kept on file as described in Annex II of the R&TTE Directive.

Furthermore, the manufacturer must maintain a copy of the T24 device user manual documentation and ensure the final product does not exceed the specified power ratings, antenna specifications, and/or installation requirements as specified in the user manual. If any of these specifications are exceeded in the final product, a submission must be made to a notified body for compliance testing to all required standards.

OEM Labelling Requirements

The 'CE' marking must be affixed to a visible location on the OEM product.

The CE mark shall consist of the initials "CE" taking the following form:

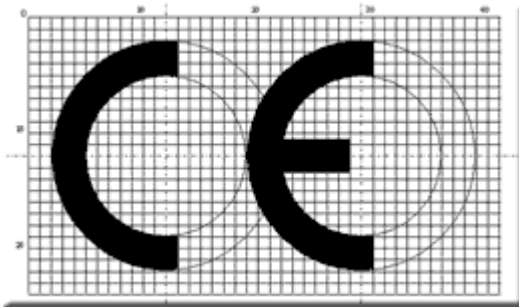

- If the CE marking is reduced or enlarged, the proportions given in the above drawing must be respected.
- The CE marking must have a height of at least 5 mm except where this is not possible on account of the nature of the apparatus.
- The CE marking must be affixed visibly, legibly, and indelibly.

IC

The RA24 Module has been certified for integration into products only by OEM integrators under the following conditions:

1. The antenna(s) must be installed such that a minimum separation distance of 5cm is maintained between the radiator (antenna) and all persons at all times.
2. The transmitter module must not be co-located or operating in conjunction with any other antenna or transmitter.

As long as the two conditions above are met, further transmitter testing will not be required. However, the OEM integrator is still responsible for testing their end-product for any additional compliance requirements required with this module installed (for example, digital device emissions, PC peripheral requirements, etc.).

IMPORTANT NOTE: In the event that these conditions cannot be met (for certain configurations or co-location with another transmitter), then Industry Canada certification is no longer considered valid and the IC Certification Number cannot be used on the final product. In these circumstances, the OEM integrator will be responsible for re-evaluating the end product (including the transmitter) and obtaining a separate Industry Canada authorization.

End Product Labelling

The RA24 Module is labelled with its own IC Certification Number. If the IC Certification Number is not visible when the module is installed inside another device, then the outside of the device into which the module is installed must also display a label referring to the enclosed module. In that case, the final end product must be labelled in a visible area with the following:

Contains Model RA24 Radio (2.4 GHz), IC:7224A-RA24

The OEM of the RA24 Module must only use the approved antenna(s) listed above, which have been certified with this module.

The OEM integrator has to be aware not to provide information to the end user regarding how to install or remove this RF module or change RF related parameters in the user's manual of the end product.

The user's manual for the end product must include the following information in a prominent location:

“To comply with Industry Canada RF radiation exposure limits for general population, the antenna(s) used for this transmitter must be installed such that a minimum separation distance of 5 cm is maintained between the radiator (antenna) and all persons at all times and must not be co-located or operating in conjunction with any other antenna or transmitter.”

FCC

The Original Equipment Manufacturer (OEM) must ensure that FCC labelling requirements are met. This includes a clearly visible label on the outside of the final product enclosure that displays the contents as shown:

Contains FCC ID:VHARA24

- This device complies with Part 15 of the FCC Rules.
Operation is subject to the following two conditions:
(1) This device may not cause harmful interference, and
(2) This device must accept any interference received, including interference that may cause undesired operation.
- This equipment complies with FCC radiation exposure limits set forth for an uncontrolled environment. End users must follow the specific operating instructions for satisfying RF exposure compliance. This transmitter must not be co-located or operating in conjunction with any other antenna or transmitter.
- Changes or modifications not expressly approved by the party responsible for compliance could void the user's authority to operate the equipment

When integrated in OEM products, fixed antennas require installation preventing end-users from replacing them with non-approved antennas. Antennas other than T24-ANTA, T24-ANTB, T24-ANTC, T24-ANTD, T24-ANTE and those listed below, must be tested to comply with FCC Section 15.203 (unique antenna connectors) and Section 15.247 (emissions).

Manufacturer Code	Description	Gain	Available From
DELTA7A	Dual band 2.4 or 5.8GHz Hinged mount whip	2.1dBi	Sequoia
DELTA14	Stubby WiFi / WLAN Antenna	2.0dBi	Sequoia
DELTA15/SMAM/RA/RP11	2.4GHz Right angle RPSMA	2.0dBi	Sequoia
1699481	AUREL ANT.RP SMA 2.4GHz	2.0dBi	Farnell Electronic Components
537-785	EAD, FBKR35068-RS-KR WiFi Antenna	2.0dBi	RS Components

Transmitter modules have been certified by the FCC for use with other products without any further certification (as per FCC section 2.1091). Changes or modifications not expressly approved by Mantracourt could void the user's authority to operate the equipment.

In order to fulfil the certification requirements, the OEM must comply with FCC regulations:

1. The system integrator must ensure that the text on the external label provided with this device is placed on the outside of the final product.
2. The transmitter modules with external antennas may be used only with Approved Antennas that have been tested by Mantracourt.

Appendix F - Worldwide Regional Approvals

Region	Product Conforms To
Europe	CE
USA	FCC
Canada	IC

Important Note

Mantracourt does not list the entire set of standards that must be met for each country. Mantracourt customers assume full responsibility for learning and meeting the required guidelines for each country in their distribution market.

For more information relating to European compliance of an OEM product incorporating the T24 range of modules, contact Mantracourt, or refer to the following web site: **www.ero.dk**

Appendix G – ATEX & IEC

Declarations and Attestations of Conformity

The following pages contain the ATEX and IECEx declarations and attestations.



1 **EU-TYPE EXAMINATION CERTIFICATE**

2 Component intended for use in Potentially Explosive Atmospheres Directive 2014/34/EU

3 Certificate Number: **Sira 15ATEX2343U** Issue: **0**

4 Component: **X24-xAyz Telemetry Transmitter Module OEM**

5 Applicant: **Mantracourt Electronics Ltd**

6 Address: The Drive
Farringdon
Exeter
Devon EX5 2JB
UK

7 This component and any acceptable variation thereto are specified in the schedule to this certificate and the documents therein referred to.

8 Sira Certification Service, notified body number 0518 in accordance with Articles 17 and 21 of Directive 2014/34/EU of the European Parliament and of the Council, dated 26 February 2014, certifies that this component has been found to comply with the Essential Health and Safety Requirements relating to the design and construction of a component intended for use in potentially explosive atmospheres given in Annex II to the Directive.

The examination and test results are recorded in the confidential reports listed in Section 14.2.

9 Compliance with the Essential Health and Safety Requirements, with the exception of those listed in the schedule to this certificate, has been assured by compliance with the following documents:

EN 60079-0:2012/A11:2013 EN 60079-11:2012

The above list of documents may detail standards that do not appear on the UKAS Scope of Accreditation, but have been added through Sira's flexible scope of accreditation, which is available on request.

10 The sign 'U' is placed after the certificate number to indicate that the product assessed is a component and may be subject to further assessment when incorporated into equipment. Any limitations of use are listed in the schedule to this certificate.

11 This EU-Type Examination Certificate relates only to the design and construction of the specified component. If applicable, further requirements of this Directive apply to the manufacture and supply of this component.

12 The marking of the component shall include the following:



I M2
Ex ib I



II 2GD
Ex ib IIC Gb
Ex ib IIIC T135°C Db
Ta = -20°C to +50°C

Project Number 70028152

This certificate and its schedules may only be reproduced in its entirety and without change.

Form 9401 Issue 4

Page 1 of 3

N Jones
Certification Manager

Sira Certification Service

Unit 6, Hawarden Industrial Park,
Hawarden, CH5 3US, United Kingdom

Tel: +44 (0) 1244 670 900
Fax: +44 (0) 1244 539 301
Email: ukinfo@csagroup.org
Web: www.csagroupuk.org



SCHEDULE

EU-TYPE EXAMINATION CERTIFICATE

**Sira 15ATEX2343U
Issue 0**

13 DESCRIPTION OF COMPONENT

The X24-xAyz is a component certified data acquisition and transmission module comprised of a data acquisition printed circuit board, a radio transmission printed circuit board and a connectivity circuit board for supply and sensor inputs. The radio circuit board contains radio data transmission circuits and an antenna connector. The radio circuit board has two component fit options for an internal or external antenna.

The character x denotes the data acquisition type (E.g. strain, pulse, voltage, etc.)

The character y denotes an optional firmware version. When this character is unused, the type format is X24-xAz

The character z denotes the antenna type (e= external, i=integrated)

The equipment has the following entity parameters:

	Supply parameters			Sensor connector parameters
	Groups I, IIC, IIIC			Groups I, IIC, IIIC
Ui	3.66V		Uo	5.5V
Ii	340mA		Io	2.25A
Pi	1.244W		Po	1.25W
Ci	43µF		Co	15µF
Li	5.64µH		Lo	1.38µH

14 DESCRIPTIVE DOCUMENTS

14.1 Drawings

Refer to Certificate Annexe.

14.2 Associated Sira Reports and Certificate History

Issue	Date	Report number	Comment
0	08 August 2016	R70028152A	The release of the prime certificate.

15 SCHEDULE OF LIMITATIONS

- 15.1 When installed in a hazardous or non-hazardous area, the equipment shall be installed in a suitably-certified enclosure.
- 15.2 A minimum ingress protection of IP54 is required for use in Group I equipment.
- 15.3 A minimum ingress protection of IP20 is required for use in Group II equipment.
- 15.4 A minimum ingress protection of IP5x is required for use in Group III equipment.
- 15.5 When installed in a non-hazardous area, the equipment may alternatively be installed in a controlled environment that provides equivalent protection. The installer shall ensure that the maximum ambient temperature of the equipment when installed is not exceeded.

This certificate and its schedules may only be reproduced in its entirety and without change.

Sira Certification Service

Unit 6, Hawarden Industrial Park,
Hawarden, CH5 3US, United Kingdom

Tel: +44 (0) 1244 670 900
Fax: +44 (0) 1244 539 301
Email: ukinfo@csagroup.org
Web: www.csagroupuk.org



SCHEDULE

EU-TYPE EXAMINATION CERTIFICATE

Sira 15ATEX2343U
Issue 0

- 16 **ESSENTIAL HEALTH AND SAFETY REQUIREMENTS OF ANNEX II (EHSRs)**
The relevant EHSRs that are not addressed by the standards listed in this certificate have been identified and individually assessed in the reports listed in Section 14.2.
- 17 **CONDITIONS OF MANUFACTURE**
- 17.1 The use of this certificate is subject to the Regulations Applicable to Holders of Sira Certificates.
- 17.2 Holders of EU-Type Examination Certificates are required to comply with the conformity to type requirements defined in Article 13 of Directive 2014/34/EU.
- 17.3 The resistance of fuse F1 must be not less than 0.517Ω at -20°C

This certificate and its schedules may only be reproduced in its entirety and without change.

Form 9401 Issue 4

Page 3 of 3

Sira Certification Service

Unit 6, Hawarden Industrial Park,
Hawarden, CH5 3US, United Kingdom

Tel: +44 (0) 1244 670 900
Fax: +44 (0) 1244 539 301
Email: ukinfo@csagroup.org
Web: www.csagroupuk.org



1 **EU-TYPE EXAMINATION CERTIFICATE**

2 Equipment intended for use in Potentially Explosive Atmospheres Directive 2014/34/EU

3 Certificate Number: **Sira 15ATEX2344X** Issue: **0**

4 Equipment: **X24-ACMi-xAy Telemetry Transmitter Module**

5 Applicant: **Mantracourt Electronics Ltd**

6 Address: The Drive
Farringdon
Exeter
Devon EX5 2JB
UK

7 This equipment and any acceptable variation thereto is specified in the schedule to this certificate and the documents therein referred to.

8 Sira Certification Service, notified body number 0518 in accordance with Articles 17 and 21 of Directive 2014/34/EU of the European Parliament and of the Council, dated 26 February 2014, certifies that this equipment has been found to comply with the Essential Health and Safety Requirements relating to the design and construction of equipment intended for use in potentially explosive atmospheres given in Annex II to the Directive.

The examination and test results are recorded in the confidential reports listed in Section 14.2.

9 Compliance with the Essential Health and Safety Requirements, with the exception of those listed in the schedule to this certificate, has been assured by compliance with the following documents:

EN 60079-0:2012/A11:2013 EN 60079-11:2012

The above list of documents may detail standards that do not appear on the UKAS Scope of Accreditation, but have been added through Sira's flexible scope of accreditation, which is available on request.

10 If the sign 'X' is placed after the certificate number, it indicates that the equipment is subject to Specific Conditions of Use identified in the schedule to this certificate.

11 This EU-Type Examination Certificate relates only to the design and construction of the specified equipment. If applicable, further requirements of this Directive apply to the manufacture and supply of this equipment.

12 The marking of the equipment shall include the following:

 I M2
Ex ib I
  II 2G
Ex ib IIC T4 Gb
Ta = -20°C to +50°C

Project Number 70028152

This certificate and its schedules may only be reproduced in its entirety and without change.



N Jones
Certification Manager

Sira Certification Service

Unit 6, Hawarden Industrial Park,
Hawarden, CH5 3US, United Kingdom

Tel: +44 (0) 1244 670 900
Fax: +44 (0) 1244 539 301
Email: ukinfo@csagroup.org
Web: www.csagroupuk.org

Form 9400 Issue 4

Page 1 of 2



SCHEDULE

EU-TYPE EXAMINATION CERTIFICATE

**Sira 15ATEX2344X
Issue 0**

13 DESCRIPTION OF EQUIPMENT

The X24-ACMi-xAy is battery powered equipment for fixed installation. It comprises an enclosure with accommodation for two Ex certified AA cells (Baseefa 14ATEX0107U), an X24-xAyz component certified data acquisition and transmission module. A printed circuit board antenna is included. This board is mounted completely within the enclosure. The enclosure is fitted with a single cable gland for all external wiring to the internal connectors. The enclosure is fitted with a translucent light pipe to permit observation of the internally mounted LED.

The character x denotes the data acquisition type (E.g. strain, pulse, voltage, etc.)

The character y denotes an optional firmware version. Without this option the type format is X24-ACMi-xA.

The equipment has the following entity parameters:

Sensor connector parameters				
Groups I and IIC				
Uo = 5.5V	Io = 2.25A at 3.66V	Po = 1.25W	Co = 15µF	Lo = 1.38µH
			Ci = 43µF	Li = 5.64µH

14 DESCRIPTIVE DOCUMENTS

14.1 Drawings

Refer to Certificate Annexe.

14.2 Associated Sira Reports and Certificate History

Issue	Date	Report number	Comment
0	08 August 2016	R70028152A	The release of the prime certificate.

15 SPECIFIC CONDITIONS OF USE (denoted by X after the certificate number)

15.1 The permitted cell type is Energizer Lithium L91, size AA. (Baseefa 14ATEX0107U).

16 ESSENTIAL HEALTH AND SAFETY REQUIREMENTS OF ANNEX II (EHSRs)

The relevant EHSRs that are not addressed by the standards listed in this certificate have been identified and individually assessed in the reports listed in Section 14.2.

17 CONDITIONS OF MANUFACTURE

17.1 The use of this certificate is subject to the Regulations Applicable to Holders of Sira Certificates.

17.2 Holders of EU-Type Examination Certificates are required to comply with the conformity to type requirements defined in Article 13 of Directive 2014/34/EU.

17.3 The resistance of fuse F1 must be not less than 0.517Ω at -20°C.

17.4 The Model X24-ACMi-xAy incorporates Ex component certified Lithium cells (Baseefa 14ATEX0107U) and an Ex component certified X24-xAyz module. It is therefore the responsibility of the manufacturer to continually monitor the status of the certification associated with these devices. The manufacturer shall inform Sira of any modifications to the device that may impinge upon the explosion safety design of the X24-ACMi-xAy.

This certificate and its schedules may only be reproduced in its entirety and without change.

Sira Certification Service

Unit 6, Hawarden Industrial Park,
Hawarden, CH5 3US, United Kingdom

Tel: +44 (0) 1244 670 900
Fax: +44 (0) 1244 539 301
Email: ukinfo@csagroup.org
Web: www.csagroupuk.org



1 **EU-TYPE EXAMINATION CERTIFICATE**

2 Equipment intended for use in Potentially Explosive Atmospheres Directive 2014/34/EU

3 Certificate Number: **Sira 15ATEX2345X** Issue: **0**

4 Equipment: **X24-Hx-yy Telemetry Handheld Display**

5 Applicant: **Mantracourt Electronics Ltd**

6 Address: The Drive
Farringdon
Exeter
Devon EX5 2JB
UK

7 This equipment and any acceptable variation thereto is specified in the schedule to this certificate and the documents therein referred to.

8 Sira Certification Service, notified body number 0518 in accordance with Articles 17 and 21 of Directive 2014/34/EU of the European Parliament and of the Council, dated 26 February 2014, certifies that this equipment has been found to comply with the Essential Health and Safety Requirements relating to the design and construction of equipment intended for use in potentially explosive atmospheres given in Annex II to the Directive.

The examination and test results are recorded in the confidential reports listed in Section 14.2.

9 Compliance with the Essential Health and Safety Requirements, with the exception of those listed in the schedule to this certificate, has been assured by compliance with the following documents:

EN 60079-0:2012/A11:2013 EN 60079-11:2012

The above list of documents may detail standards that do not appear on the UKAS Scope of Accreditation, but have been added through Sira's flexible scope of accreditation, which is available on request.

10 If the sign 'X' is placed after the certificate number, it indicates that the equipment is subject to Specific Conditions of Use identified in the schedule to this certificate.

11 This EU-Type Examination Certificate relates only to the design and construction of the specified equipment. If applicable, further requirements of this Directive apply to the manufacture and supply of this equipment.

12 The marking of the equipment shall include the following:

 I M2
Ex ib I
  II 2G
Ex ib IIC T4 Gb
Ta = -20°C to +50°C

Project Number 70028152

This certificate and its schedules may only be reproduced in its entirety and without change.

 N Jones
 Certification Manager

Sira Certification Service

Unit 6, Hawarden Industrial Park,
Hawarden, CH5 3US, United Kingdom

Tel: +44 (0) 1244 670 900
 Fax: +44 (0) 1244 539 301
 Email: ukinfo@csagroup.org
 Web: www.csagroupuk.org

Form 9400 Issue 4

Page 1 of 2



SCHEDULE

EU-TYPE EXAMINATION CERTIFICATE

**Sira 15ATEX2345X
Issue 0**

13 DESCRIPTION OF EQUIPMENT

The **X24-Hx-yy** is battery powered, handheld equipment for radio data capture and display. It comprises an enclosure accommodating two Ex certified AA cells (Baseefa 14ATEX0107U), an antenna printed circuit board, a printed circuit board with a liquid crystal data display and radio module. The printed circuit board is connected by ribbon cable to the front panel of the enclosure which contains six membrane switches.

The character x denotes functionality. The characters yy denotes front panel graphic variations

Data transmission and reception is by radio. Entity parameters are not required because there are no external connections.

14 DESCRIPTIVE DOCUMENTS

14.1 Drawings

Refer to Certificate Annexe.

14.2 Associated Sira Reports and Certificate History

Issue	Date	Report number	Comment
0	08 August 2016	R70028152A	The release of the prime certificate.

15 SPECIFIC CONDITIONS OF USE (denoted by X after the certificate number)

15.1 The permitted cell type is Energizer Lithium L91, size AA (Baseefa 14ATEX0107U).

15.2 No precautions against electrostatic discharge are necessary for portable equipment that has an enclosure made of plastic, metal or a combination of the two, except where a significant static-generating mechanism has been identified. Activities such as placing the item in a pocket or on a belt, operating a keypad or cleaning with a damp cloth, do not present a significant electrostatic risk. However, where a static-generating mechanism is identified, such as repeated brushing against clothing, then suitable precautions shall be taken, e.g. the use of anti-static footwear.

16 ESSENTIAL HEALTH AND SAFETY REQUIREMENTS OF ANNEX II (EHSRs)

The relevant EHSRs that are not addressed by the standards listed in this certificate have been identified and individually assessed in the reports listed in Section 14.2.

17 CONDITIONS OF MANUFACTURE

17.1 The use of this certificate is subject to the Regulations Applicable to Holders of Sira Certificates.

17.2 Holders of EU-Type Examination Certificates are required to comply with the conformity to type requirements defined in Article 13 of Directive 2014/34/EU.

17.3 The resistance of fuse F1 must be not less than 0.517Ω at -20°C.

17.4 The Model X24-HX-YY incorporates Ex component certified Lithium cells (Baseefa 14ATEX0107U). It is therefore the responsibility of the manufacturer to continually monitor the status of the certification associated with this device. The manufacturer shall inform Sira of any modifications to the device that may impinge upon the explosion safety design of the X24-HX-YY.

This certificate and its schedules may only be reproduced in its entirety and without change.

Sira Certification Service

Unit 6, Hawarden Industrial Park,
Hawarden, CH5 3US, United Kingdom

Tel: +44 (0) 1244 670 900
Fax: +44 (0) 1244 539 301
Email: ukinfo@csagroup.org
Web: www.csagroupuk.org

IEX Ex Certificates of Conformity

The following pages contain the ATEX and IECEx declarations and attestations.

EU ATTESTATION OF CONFORMITY

Declaration No. X24-xAyz-ATEX-DOC

We, the undersigned:

Name of Manufacturer: **Mantracourt Electronics Ltd**
 Address: **The Drive, Farrington, Exeter, Devon, EX5 2JB**
 Country: **United Kingdom**

Declare under our sole responsibility that the following apparatus:

Product description: **ATEX Telemetry Acquisition Module OEM**
 Model or Type No.: **X24-SAe, X24-SAi**
 Brand name: **X24**

Is in conformity with the following relevant Union harmonisation legislation: Based on the following harmonised standards:

ATEX directive 2014/34/EU	EN 60079-0:2012+A11:2013	EN 60079-11:2012
EMC directive 2014/30/EU	EN 61326-2-3:2013	EN 61326-1:2013
Radio Equipment Directive 2014/53/EU	EN 300328 V2.1.1	

And therefore complies with the following essential requirements of the ATEX Directive (2014/34/EU) and with the relevant essential requirements of those other directives.

The following Notified Body has been involved in the conformity assessment process:

Notified Body: **CSA Group**
 Notified Body No.: **0518**
 Role: **Issue of ATEX EU Type Examination certificate**
 Certificate No.: **SIRA 15ATEX2343U**
IECEX SIR 15.0123U

Additional information:

ATEX coding: **II 2 G**
I M2

IECEX coding: **Ex ib IIC T4 Gb**
Ex ib I



Guidelines for incorporation:
 Requires an appropriate enclosure as set out in the component certificate.

This component must not be put into service until the final ATEX equipment into which it is to be incorporated has been declared in conformity with the provisions of the ATEX Directive (2014/34/EU).

Name and position of person binding the manufacturer or authorised representative:

Signature: 

Name: **Mr Brett James**
 Function: **Design Manager**
 Location: **Mantracourt Electronics Ltd**
 Date of issue: **19th October 2017**



Mantracourt Electronics Ltd
 The Drive, Farrington
 Exeter, Devon EX5 2JB
 United Kingdom

Tel: +44(0) 1395 232020
 Fax: +44(0) 1395 233190
 info@mantracourt.com
 mantracourt.com

EU DECLARATION OF CONFORMITY

Declaration No. X24-ACMI-xAy-ATEX-DOC

We, the undersigned:

Name of Manufacturer: **Mantracourt Electronics Ltd**
 Address: **The Drive, Farrington, Exeter, Devon, EX5 2JB**
 Country: **United Kingdom**

Declare under our sole responsibility that the following apparatus:

Product description: **ATEX Telemetry Acquisition Module**
 Model or Type No.: **X24-ACMI-SA**
 Brand name: **X24**

Is in conformity with the following relevant Union harmonisation legislation: **ATEX directive 2014/34/EU**
EMC directive 2014/30/EU
Radio Equipment Directive 2014/53/EU

Based on the following harmonised standards:
EN 60079-0:2012+A11:2013 **EN 60079-11:2012**
EN 61326-2-3:2013 **EN 61326-1:2013**
EN 300328 V2.1.1

The following Notified Body has been involved in the conformity assessment process:

Notified Body: **CSA Group**
 Notified Body No.: **0518**
 Role: **Issue of ATEX EU Type Examination certificate**
 Certificate No.: **SIRA 15ATEX2344X**
IECEx SIR 15.0124X

Additional information:

ATEX coding: **II 2 G**
I M2

IECEx coding: **Ex ib IIC T4 Gb**
Ex ib I

 **II 2 G** **Ex ib IIC T4 Gb**
I M2 **Ex ib I**

Name and position of person binding the manufacturer or authorised representative:

Signature: 

Name: **Mr Brett James**
 Function: **Design Manager**
 Location: **Mantracourt Electronics Ltd**
 Date of issue: **19th October 2017**



 Mantracourt Electronics Ltd
 The Drive, Farrington
 Exeter, Devon EX5 2JB
 United Kingdom
 Tel: +44(0) 1395 232020
 Fax: +44(0) 1395 233190
 info@mantracourt.com
 mantracourt.com

EU DECLARATION OF CONFORMITY

Declaration No. X24-Hx-yy-ATEX-DOC

We, the undersigned:

Name of Manufacturer:	Mantracourt Electronics Ltd
Address:	The Drive, Farringdon, Exeter, Devon, EX5 2JB
Country:	United Kingdom

Declare under our sole responsibility that the following apparatus:

Product description:	ATEX Telemetry Handheld Display
Model or Type No.:	X24-HD
Brand name:	X24

Is in conformity with the following relevant Union harmonisation legislation: Based on the following harmonised standards:

ATEX directive 2014/34/EU	EN 60079-0:2012+A11:2013	EN 60079-11:2012
EMC directive 2014/30/EU	EN 61326-2-3:2013	EN 61326-1:2013
Radio Equipment Directive 2014/53/EU	EN 300328 V2.1.1	

The following Notified Body has been involved in the conformity assessment process:

Notified Body:	CSA Group
Notified Body No.:	0518
Role:	Issue of ATEX EU Type Examination certificate
Certificate No.:	SIRA 15ATEX2345X IECEx SIR 15.0125X

Additional information:

ATEX coding:		IECEx coding:
	II 2 G I M2	Ex ib IIC T4 Gb Ex ib I

Name and position of person binding the manufacturer or authorised representative:

Signature:	
Name:	Mr Brett James
Function:	Design Manager
Location:	Mantracourt Electronics Ltd
Date of issue:	19th October 2017



mantracourt
 Mantracourt Electronics Ltd
 The Drive, Farringdon
 Exeter, Devon EX5 2JB
 United Kingdom
 Tel: +44(0) 1395 232020
 Fax: +44(0) 1395 233190
 info@mantracourt.com
 mantracourt.com

Warranty

All Telemetry products from Mantracourt Electronics Ltd., ('Mantracourt') are warranted against defective material and workmanship for a period of one (1) year from the date of dispatch.

If the 'Mantracourt' product you purchase appears to have a defect in material or workmanship or fails during normal use within the period, please contact your Distributor, who will assist you in resolving the problem. If it is necessary to return the product to 'Mantracourt' please include a note stating name, company, address, phone number and a detailed description of the problem. Also, please indicate if it is a warranty repair.

The sender is responsible for shipping charges, freight insurance and proper packaging to prevent breakage in transit.

'Mantracourt' warranty does not apply to defects resulting from action of the buyer such as mishandling, improper interfacing, operation outside of design limits, improper repair or unauthorised modification.

No other warranties are expressed or implied. 'Mantracourt' specifically disclaims any implied warranties of merchantability or fitness for a specific purpose.

The remedies outlined above are the buyer's only remedies. 'Mantracourt' will not be liable for direct, indirect, special, incidental or consequential damages whether based on the contract, tort or other legal theory.

Any corrective maintenance required after the warranty period should be performed by 'Mantracourt' approved personnel only.

Advanced Intelligent Instrumentation

Document Title: **X24 ATEX Telemetry User Manual**
Applies To: **X24 Product Range**
Part Number: **517-938**
Issue Number: **01.02a**
Dated: **28th February 2019**

In the interests of continued product development, Mantracourt Electronics Limited reserves the right to alter product specifications without prior notice.



www.mantracourt.com