DSCRC Pancake Load Cell

Key Features:

- Capacities 0-200N up to 0-2000N
- Output: 2mV/V
- Stainless Steel Construction
- High Accuracy $<\pm 0.1\%$ /Rated Capacity
- Low Profile Design
- Simple Installation
- 3 Year Warranty



For Weighing and Force Measurement Applications

The DSCRC series of pancake load cells are designed for weighing and force measurement applications and can operate in both tension and compression. They are perfectly suited for material and component fatigue testing applications where a high accuracy, low height device is required and forces are applied axially.

The DSCRC can be entirely customised to suit your specific application, with alternative threads, dimensions and customer specific capacities.

For a pancake load cell with a rated capacity greater than 0-2kN, please see our [DSCC pancake load cells](#) which cover forces from 0-5kN up to 0-1000kN as standard.

Options:

- Shunt Calibration Facility
- Custom Dimensions
- Full Range of Mounting Options inc.: Load Buttons, Spherical Rod End Bearings, Mounting Bases.
- Fatigue Rated Versions
- Alternative Threads
- Integral Cable Versions
- USB Versions (via DSC-USB)
- Vacuum/Pressurised Environment Version
- High/Low Temperature Versions
- TEDS (Transducer Electronic Data Sheet)
- TEDS Allows Plug & Play with TEDS Enabled Instrumentation.
- Single or Multi-Channel PC-Based Monitoring & Data Logging System.
- Wireless Version (via T24 instrumentation)

Applications:





- Materials Testing
 - Component Fatigue Testing
 - Calibration & Testing Machines
 - General Load & Force Measurement
 - Press Force Monitoring & Verification
 - Test Stand Force Measurement
-

Specification:

Rated Capacity (RC)	N	0-200, 0-500, 0-1000, 0-2000
Operating Modes	Tension/Compression / Tension & Compression	
Sensitivity (RO)	mV/V	2.0 nominal (1.0 on fatigue-rated versions)
Zero Balance/Offset	±%/Rated Output	<5.0
Output Symmetry (tension vs. compression)	%/Rated Output	<0.5 typical
Non-Linearity	±%/Rated Output	<0.10
Hysteresis	%/Rated Output	<0.08
Repeatability	±%/Applied Load	<0.03
Temperature Effect on Zero	±%/Rated Capacity/ °C	<0.005
Temperature Effect on Sensitivity	±%/Applied Load/ °C	<0.005
Input Resistance	Ohms	375 nominal
Output Resistance	Ohms	350 nominal
Insulation Resistance	Megohms	>5000 @ 50Vdc
Excitation Voltage	Volts AC or DC	10 recommended (2-15 acceptable)
Operating Temperature Range	°C	-20 to +80
Compensated Temperature Range	°C	0 to +60
Storage Temperature Range	°C	-20 to +80
Safe Overload	% of Rated Capacity	150
Ultimate Overload	% of Rated Capacity	300
Deflection @ Rated Capacity	mm	<0.4 nominal
Fundamental Resonant Frequency*		See table
IP Rating (Environmental Protection)		IP65 (2000N version) / IP52 (1000N and below)
Weight (excluding cable)	kg	0.75 (1.65 with base)
Fatigue Life		10 ⁸ cycles typical (10 ⁹ cycles on fatigue-rated version)
Cable Length (as standard)	metres	3
Cable Type		4 core screened, PUR sheath, Ø5
Electrical Connections		6 Pin Bayonet Lock Connector (MIL-C-26482-10-6P) + mating cable assembly
Construction Material		Stainless Steel
Resolution		1 part in 250,000 (with appropriate instrumentation)

*The resonant frequency is calculated with the body of the load cell attached to a large plate, ensuring that only the sensing element oscillates: This is vital to achieve the highest natural frequency and subsequent frequency response.

Wiring Diagram:

Wire	Designation
 Red	+ve excitation
 Blue	-ve excitation
 Green	+ve signal (compression)
 Yellow	-ve signal
 Screen	To ground - not connected to load cell body

Dimensions (mm):

CAPACITY (N)	ØD	H	G	K	T	ØP	R	Natural Frequency (kHz)
0-200	76	25	60	6off, Ø7	M10x1.0	11	7	1.5
0-500	76	25	60	6off, Ø7	M10x1.0	11	7	2.2
0-1000	76	25	60	6off, Ø7	M10x1.0	11	7	3
0-2000	76	25	60	6off, Ø7	M10x1.0	11	7	4

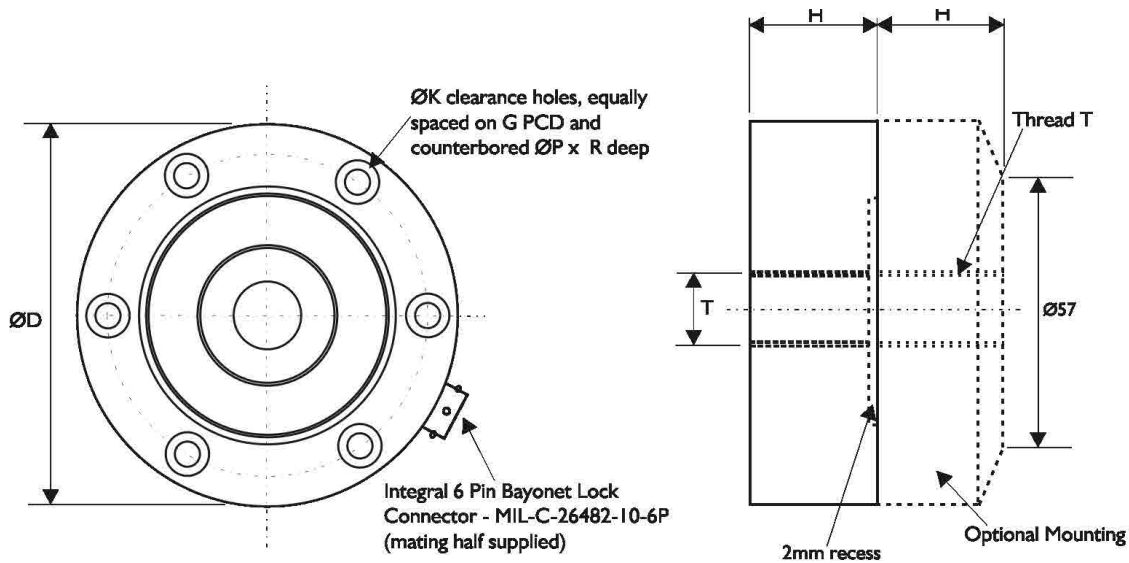

Ordering Codes:

Core Product	Capacity (inc Engineering Units)	Cable Length (m)	Specials Code	Example Result
DSCRC	200N	003	000	DSCRC-200N-003-000
DSCRC	500N	003	000	DSCRC-500N-003-000
DSCRC	1000N	003	000	DSCRC-1000N-003-000
DSCRC	2000N	003	000	DSCRC-2000N-003-000

Associated Products:



[TR150 Handheld Indicator](#)



[T24 Wireless Telemetry Range](#)



[Intuitive4-L Panel-Mount Indicator](#)



[DSC-USB USB Signal Digitiser](#)



[ICA Miniature Strain Gauge Amplifier](#)



[SGA Signal Conditioner/Amplifier](#)

Mounting and Installation Accessories:

Helping You Get The Best Possible Performance From Your Load Cell.

Load Buttons and Rod End Bearings

Designed to align forces through the principle axis of the load cell thus reducing the effects of extraneous forces, hence offering improved performance from the cell.

Load buttons are used where compressive forces are applied.

Rod End Bearings are used where tensile forces are being applied.

Dimensions in mm:

Load Buttons for Compression Use

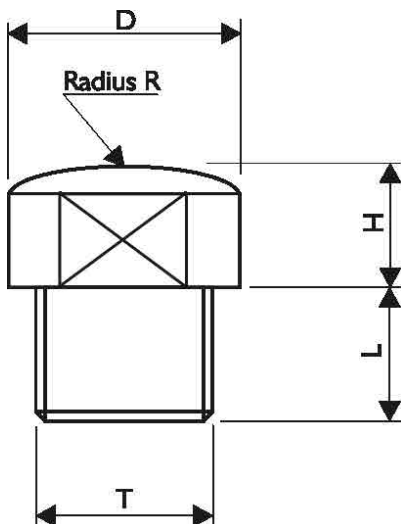

THREAD T	M10x 1.0
D	16
H	6
L	10
R	150

Rod End Bearings for Tension Use

Maintenance-free rod ends are a complete units made up of a housing with both an integral shank (with an internal or external thread) and a maintenance-free spherical plain bearing, located within the housing.

Key Features:

- Supports radial loads in a tensile or compressive direction.
- Suitable for unilateral loads - can support alternating loads and alternating loads in combination with bearing GE.. UK-2RS, please consult sales.
- Are maintenance-free.
- Hard chromium/PTFE composite sliding contact surfaces.
- Enables compact adjacent construction thanks to its thin walled design of the eye housing.

Series GAXSW..MS



Rod ends with male thread made from heat-treated steel, nickel plated with PTFE liner, maintenance free.

Preloaded bearing.

Materials:	
Housing	Heat-treated steel to 42CrMo4, Aisi 4140, forged, polished, nickel plated with high polish finish.
Insert	Stainless Steel to 1.4571, Aisi 316Ti with PTFE liner bonded to inner surface.
Ball	Bearing steel to 100Cr6, Aisi 52100, hardened, ground, polished, hard chrome plated on the running surface.
Clearance	Preloaded, zero tollerance.
On Request	With left hand thread, threaded bolt and further sizes are available

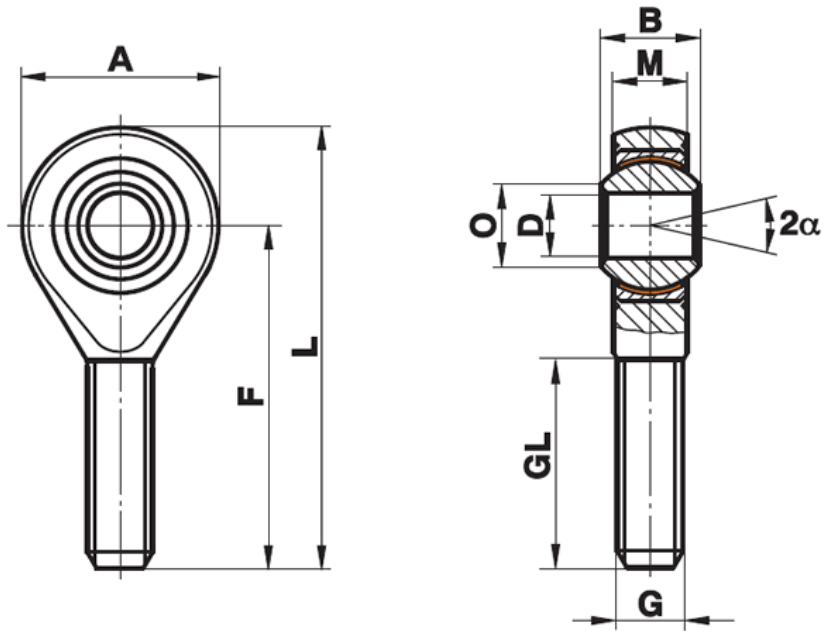

Load Cell	Ordering Code	DH7	B	M	A	F	L	O	G	GL	Static radial load C_0 kN	Dynamic radial load C_0 kN	torque N/dm	α	weight gr
DSCRC 200N to 2000N	GAXSW 10x1 MS	10	14	10.50	28	48	62	12.9	M 10x1	29	31.4	28.1	6-16	13°	56