



# INTRINSICALLY SAFE

## Pressure Transducer / Transmitter

### AST4400

#### Overview

The AST4400 is a stainless steel pressure transducer with a wide variety of options. With its rugged construction and best price-to-performance ratio in the industry, the AST4400 is the solution for pressure measurement in Intrinsically Safe areas.

#### Benefits

- Class I Div 1 Intrinsically Safe Groups C, D when installed with an approved barrier
- ATEX / IECEx: Class I Zone 0 Exia IIB T4 Ga (Ta = -40°C to +80°C)
- High Strength Stainless Steel Construction
- No Oil, Welds or Internal O-rings
- Wide Operating Temperature
- Pressures up to 20,000 PSI
- Low Static and Thermal Errors
- Unparalleled Price and Performance
- Compatible with Wide Variety of Liquids and Gases

#### Applications

- Industrial OEM Equipment
- HVAC/R Equipment
- Water Management
- Control Panels
- Pneumatics
- Hydraulic Systems
- Data Loggers

## Environmental Data

### Ambient Temperature: 25°C (77°F) (Unless otherwise specified)

Operating Ambient	-40 to 80°C (-40 to 176°F)
Storage	-40 to 100°C (-40 to 212°F)

### Electromagnetic Compatibility (EMC)

Standard	Description	Test Value
EN55011	Radiated Emissions	Class A, 30-1000 MHz
EN61000-4-2	Electrostatic Discharge Immunity	±8 kV Air Discharge ±4 kV Contact Discharge, VCP, HCP
EN61000-4-3	Radiated Electromagnetic Field Immunity	10V/m, 80-2700 MHz 80% 1kHz AM Modulation
EN61000-4-4	Electrical Fast Transient/Burst Immunity	±0.5 kV, ±1 kV, ±2 kV on DC Mains ±0.5 kV, ±1 kV on I/O Ports
EN61000-4-5	Surge Immunity	±0.5 kV, ±1 kV, on I/O Ports & DC Lines
EN61000-4-6	Conducted immunity	10V rms, 0.15-80 MHz, DC Mains 10V rms, 0.15-80 MHz, I/O Ports 80% 1kHz AM Modulation
EN61000-4-8	Power Frequency Magnetic Field Immunity Test	30 A/m @ (50Hz, 60Hz) 3 orthogonal orientations

### Shock, Vibration & Ingress Protection (IP)

Standard	Description	Test Value
EN 60067-2-27	Shock Test	500m/s <sup>2</sup> , 6ms, half sine-wave, 6 shocks (3/direction), horizontal and vertical axis, 12 total shocks
EN 60068-2-6	Sinusoidal Vibration	5-25 Hz, 2mm, 25-150 Hz, 50m/s, Sweep rate: 1 octave/min, Duration: 24 hours/axis (48 hours total), horizontal and vertical axis
EN 60068-2-64	Random Vibration	10-2000 Hz, vibration level: 0.0314 (m/s <sup>2</sup> ) <sup>2</sup> /Hz, 24 hrs/axis (48 hrs total), 2 directions: horizontal and vertical
IEC 60068-2-32	Drop Test	Drop of 1 meter to floor made of concrete. Dropped twice on the threaded end and two times perpendicular to the threaded end.
IP-66	Ingress Protection	Dust-tight, protected against powerful water jets

**Performance**

**Ambient Temperature: 25°C (77°F) (Unless otherwise specified)**

Parameters	MIN	TYP	MAX	UNITS	NOTES
Accuracy	-0.25		+0.25	%Span	1
Zero Error	-1.0		+1.0	%Span	2
Span Error	-2.0		+2.0	%Span	3
Thermal Error, Zero	-1.5		+1.5	%Span	4
Thermal Error, Span	-1.5		+1.5	%Span	5
Stability (1 year)		±0.25		%Span	
Proof Pressure		2X Rated Pressure		PSI	6
Burst Pressure		5X Rated Pressure or 40,000 (whichever is less)		PSI	7
Compensated Temp. Range		0 - 55° (32 to 132°)		°C (°F)	

**Electrical Data**

Model	AST4400		
Output	4-20mA	1-5V, 1-6V	0.5-4.5V Ratiometric
Excitation	10-28VDC	10-28VDC	5.0 ± 0.5VDC
Output Impedance	> 10k Ω	< 100 Ω	< 100 Ω
Current Consumption	-	<10mA	<10mA
Output Noise	-	<2mV RMS	<2mV RMS
Output Load	0-800Ω	10k Ω Min.	10k Ω Min.
Reverse Polarity Protection	Yes	Yes	Yes
Bandwidth	DC-250 Hz	DC-1kHz	DC-1kHz

**Notes**

1. The maximum deviation from a best fit straight line (BFSL) fitted to the output measured over the pressure range at 25°C. Includes all errors due to pressure non-linearity, hysteresis, and non-repeatability. Span is the algebraic difference between full scale output and zero pressure offset.
2. The maximum variation from the ideal offset measured at 25°C.
3. The maximum variation from the ideal full-scale span measured at 25°C.
4. The maximum variation of offset within the compensated temperature range relative to 25°C.
5. The maximum variation of full-scale span within the compensated temperature range relative to 25°C.
6. The maximum pressure that can be safely applied to the product for it to remain in specification once pressure is returned to the operating pressure range.
7. The maximum pressure that can be applied without causing escape of the pressure media.

**Dimensions & Electrical Connection**

Unless otherwise specified, all dimensions are in inches

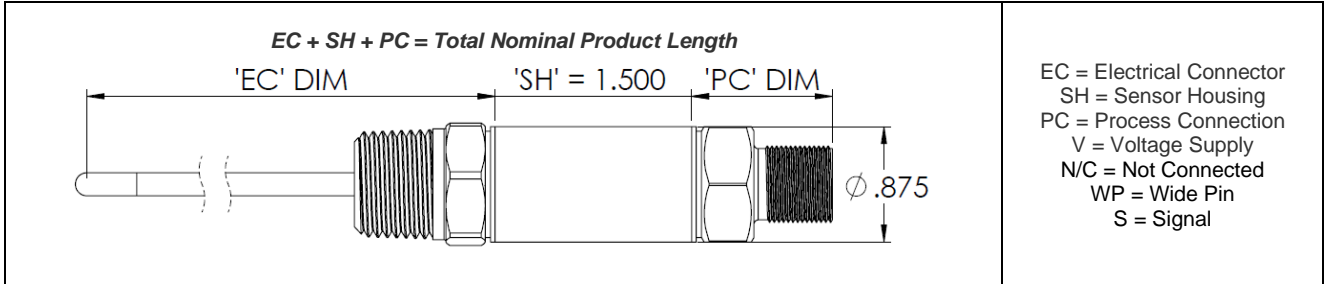

**Electrical Connectors Option Codes**

**Cable**

<b>A</b> 2ft (0.6m)	<b>B</b> 4ft (1.2m)	<b>C</b> 6ft (1.8m)	<b>D</b> 10ft (3m)
------------------------	------------------------	------------------------	-----------------------

Color	3 Wire Voltage	4-20mA
Green	N/C	N/C
Green (-SS only)	Case	Case
Black	GND	-V
Red	+V	+V
White	S	N/C

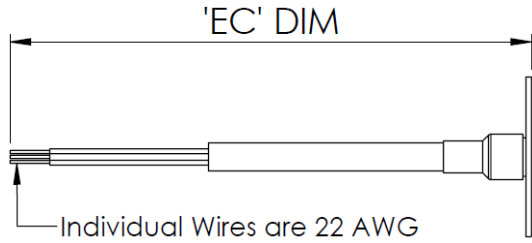

**Conduit Cable**

<b>L</b> 2ft (0.6m)	<b>M</b> 4ft (1.2m)	<b>N</b> 6ft (1.8m)	<b>P</b> 10ft (3m)
------------------------	------------------------	------------------------	-----------------------

Color	3 Wire Voltage	4-20mA
Green	N/C	N/C
Green (-SS only)	Case	Case
Black	GND	-V
Red	+V	+V
White	S	N/C

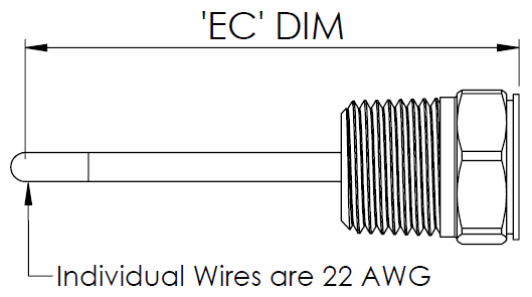

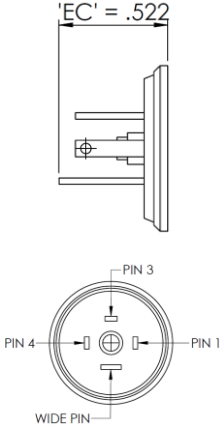
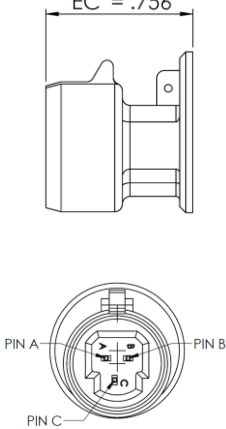
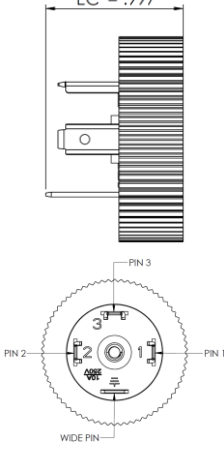
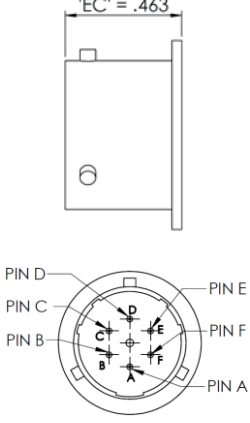
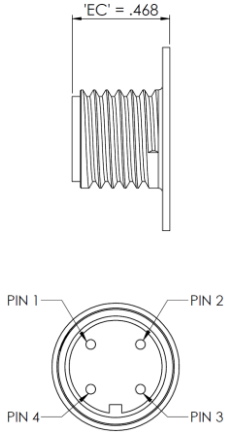
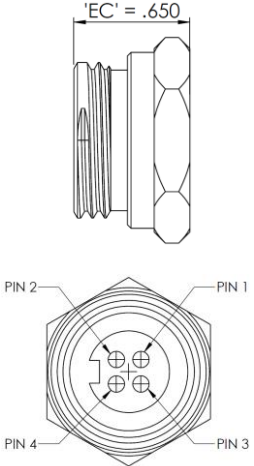
Electrical Connectors Option Codes																																																																														
<b>E</b> <b>DIN 43650C 8.0mm</b> <b>(Mini-DIN)</b>	<b>F</b> <b>Packard Metripack, 150</b>	<b>I</b> <b>DIN 43650A 18.0mm</b> <b>(Big- DIN)</b>	<b>R</b> <b>6 Pin Bendix</b>																																																																											
 <table border="1" data-bbox="170 867 475 1014"> <thead> <tr> <th>Pin</th> <th>3 Wire Voltage</th> <th>4-20mA</th> </tr> </thead> <tbody> <tr><td>1</td><td>S</td><td>N/C</td></tr> <tr><td>2</td><td>GND</td><td>-V</td></tr> <tr><td>3</td><td>+V</td><td>+V</td></tr> <tr><td>WP</td><td>N/C</td><td>N/C</td></tr> <tr><td>WP (-SS only)</td><td>Case</td><td>Case</td></tr> </tbody> </table>	Pin	3 Wire Voltage	4-20mA	1	S	N/C	2	GND	-V	3	+V	+V	WP	N/C	N/C	WP (-SS only)	Case	Case	 <table border="1" data-bbox="500 877 805 1003"> <thead> <tr> <th>Pin</th> <th>3 Wire Voltage</th> <th>4-20mA</th> </tr> </thead> <tbody> <tr><td>A</td><td>GND</td><td>-V</td></tr> <tr><td>B</td><td>+V</td><td>+V</td></tr> <tr><td>C</td><td>S</td><td>N/C</td></tr> <tr><td>C (-SS Only)</td><td>Not Available</td><td>Not Available</td></tr> </tbody> </table>	Pin	3 Wire Voltage	4-20mA	A	GND	-V	B	+V	+V	C	S	N/C	C (-SS Only)	Not Available	Not Available	 <table border="1" data-bbox="833 867 1130 1014"> <thead> <tr> <th>Pin</th> <th>3 Wire Voltage</th> <th>4-20mA</th> </tr> </thead> <tbody> <tr><td>1</td><td>+V</td><td>+V</td></tr> <tr><td>2</td><td>GND</td><td>-V</td></tr> <tr><td>3</td><td>S</td><td>N/C</td></tr> <tr><td>WP</td><td>N/C</td><td>N/C</td></tr> <tr><td>WP (-SS Only)</td><td>Case</td><td>Case</td></tr> </tbody> </table>	Pin	3 Wire Voltage	4-20mA	1	+V	+V	2	GND	-V	3	S	N/C	WP	N/C	N/C	WP (-SS Only)	Case	Case	 <table border="1" data-bbox="1162 846 1455 1035"> <thead> <tr> <th>Pin</th> <th>3 Wire Voltage</th> <th>4-20mA</th> </tr> </thead> <tbody> <tr><td>A</td><td>+V</td><td>+V</td></tr> <tr><td>B</td><td>S</td><td>-V</td></tr> <tr><td>C</td><td>N/C</td><td>N/C</td></tr> <tr><td>D</td><td>GND</td><td>N/C</td></tr> <tr><td>E</td><td>N/C</td><td>N/C</td></tr> <tr><td>F</td><td>N/C</td><td>N/C</td></tr> <tr><td>F (-SS only)</td><td>Case</td><td>Case</td></tr> </tbody> </table>	Pin	3 Wire Voltage	4-20mA	A	+V	+V	B	S	-V	C	N/C	N/C	D	GND	N/C	E	N/C	N/C	F	N/C	N/C	F (-SS only)	Case	Case
Pin	3 Wire Voltage	4-20mA																																																																												
1	S	N/C																																																																												
2	GND	-V																																																																												
3	+V	+V																																																																												
WP	N/C	N/C																																																																												
WP (-SS only)	Case	Case																																																																												
Pin	3 Wire Voltage	4-20mA																																																																												
A	GND	-V																																																																												
B	+V	+V																																																																												
C	S	N/C																																																																												
C (-SS Only)	Not Available	Not Available																																																																												
Pin	3 Wire Voltage	4-20mA																																																																												
1	+V	+V																																																																												
2	GND	-V																																																																												
3	S	N/C																																																																												
WP	N/C	N/C																																																																												
WP (-SS Only)	Case	Case																																																																												
Pin	3 Wire Voltage	4-20mA																																																																												
A	+V	+V																																																																												
B	S	-V																																																																												
C	N/C	N/C																																																																												
D	GND	N/C																																																																												
E	N/C	N/C																																																																												
F	N/C	N/C																																																																												
F (-SS only)	Case	Case																																																																												
<b>Y</b> <b>M12X1</b>	<b>4</b> <b>Mini-Fast (-SS Only)</b>																																																																													
 <table border="1" data-bbox="345 1633 634 1780"> <thead> <tr> <th>Pin</th> <th>3 Wire Voltage</th> <th>4-20mA</th> </tr> </thead> <tbody> <tr><td>1</td><td>+V</td><td>+V</td></tr> <tr><td>2</td><td>N/C</td><td>N/C</td></tr> <tr><td>2 (-SS only)</td><td>Case</td><td>Case</td></tr> <tr><td>3</td><td>GND</td><td>-V</td></tr> <tr><td>4</td><td>S</td><td>N/C</td></tr> </tbody> </table>	Pin	3 Wire Voltage	4-20mA	1	+V	+V	2	N/C	N/C	2 (-SS only)	Case	Case	3	GND	-V	4	S	N/C	 <table border="1" data-bbox="995 1654 1292 1770"> <thead> <tr> <th>Pin</th> <th>3 Wire Voltage</th> <th>4-20mA</th> </tr> </thead> <tbody> <tr><td>1</td><td>GND</td><td>-V</td></tr> <tr><td>2</td><td>S</td><td>N/C</td></tr> <tr><td>3</td><td>+V</td><td>+V</td></tr> <tr><td>4</td><td>Case</td><td>Case</td></tr> </tbody> </table>			Pin	3 Wire Voltage	4-20mA	1	GND	-V	2	S	N/C	3	+V	+V	4	Case	Case																																										
Pin	3 Wire Voltage	4-20mA																																																																												
1	+V	+V																																																																												
2	N/C	N/C																																																																												
2 (-SS only)	Case	Case																																																																												
3	GND	-V																																																																												
4	S	N/C																																																																												
Pin	3 Wire Voltage	4-20mA																																																																												
1	GND	-V																																																																												
2	S	N/C																																																																												
3	+V	+V																																																																												
4	Case	Case																																																																												

Pressure Port Option Codes			
<b>A</b> <b>1/4 NPT Male</b>	<b>B</b> <b>1/8 NPT Male</b>	<b>C</b> <b>1/4 BSPP Male</b>	<b>F</b> <b>7/16 – 20 UNF Male</b>
<p>'PC' = 1.069</p>	<p>'PC' = .975</p>	<p>'PC' = .987</p>	<p>'PC' = .978</p>
<b>I</b> <b>1/4 NPT Female</b>	<b>P</b> <b>1/2 NPT Male</b>	<b>W</b> <b>F250C Female Autoclave</b>	
<p>'PC' = .669</p>	<p>'PC' = 1.172</p>	<p>'PC' = 1.870</p>	

**UL Approved Barrier Installation / A01657**

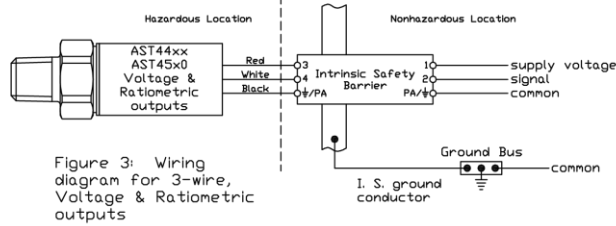
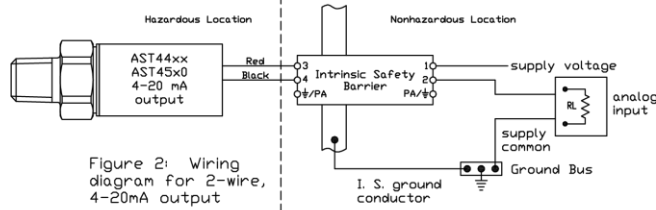
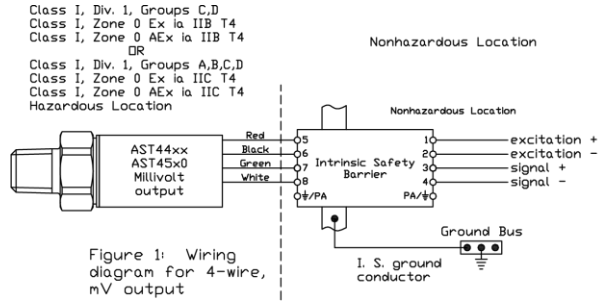

The transducers listed below are designed for installation in EITHER Class I, Division 1, Groups C,D; Class I, Zone 0 Group IIB DR; Class I, Division 1, Groups A,B,C,D; Class I, Zone 0 Group IIC hazardous locations when connected to Associated Apparatus as described in note 1.

**Entity Parameters**

Models AST4400, AST44LP, AST4500, AST4510, AST4520

Class I, Div. 1, Groups C,D; Class I, Zone 0 Ex Ia IIB T4; Class I, Zone 0 AEx Ia IIB T4  
Vmax = 28V

Model AST4401

Class I, Div. 1, Groups A,B,C,D; Class I, Zone 0 Ex Ia IIC T4; Class I, Zone 0 AEx Ia IIC T4  
Vmax = 14.5V

4-20mA with integral connector	4-20mA with upto 1000ft of integral cable	All EXCEPT 4-20mA with integral connector	All EXCEPT 4-20mA with upto 150ft of integral cable
Pmax = 651 mW Imax = 93 mA Ci = 0.391 uF Li = 0 uH	Pmax = 651 mW Imax = 93 mA Ci = 0.434 uF Li = 0 uH	Pmax = 651 mW Imax = 93 mA Ci = 0.643 uF Li = 0 uH	Pmax = 651 mW Imax = 93 mA Ci = 0.649 uF Li = 0 uH

Isc or Io is the total current available from the Associated Apparatus under any condition

1. The following conditions must be satisfied:

$$V_{oc} \text{ or } U_o \leq V_{max}$$

$$I_{sc} \text{ or } I_o \leq I_{max}$$

$$P_o \leq P_i \text{ (if applicable)}$$

Total customer cable length for 4-20mA transmitters not to exceed 4000ft.  
Total customer cable length for all other transmitters not to exceed 150ft.  
Where the cable capacitance and inductance per foot are not known, the following values shall be used: Ccable = 60pF/ft, Lcable = 0.2uH/ft

2. Control Room apparatus shall not generate in excess of 250V (Umax).

3. Canadian installations should be in accordance with Canadian Electrical Code, Part I. U.S. installations should be in accordance with Article 504 in the National Electrical Code, ANSI/NFPA 70.

**CSA Approved Barrier Installation / A08949**

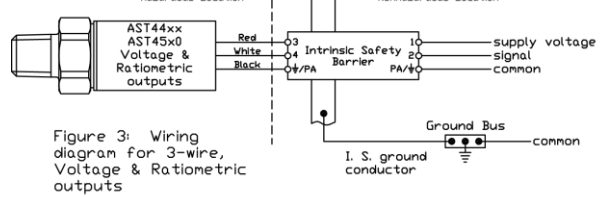
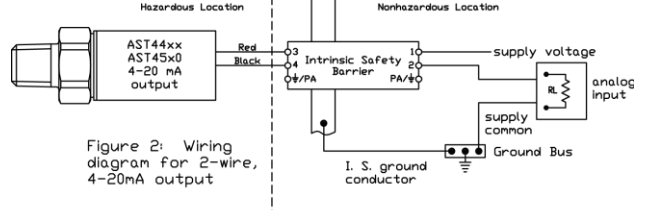
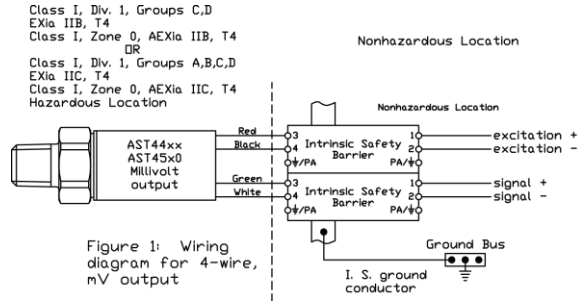

**Entity Parameters**

Models AST4400, AST44LP, AST4500, AST4510, AST4520, AST4530  
Class I, Div. 1, Groups C,D; EXIa IIB, T4; Class I, Zone 0, AEXIa IIB, T4  
Vmax = 28Vdc

Model AST4401

Class I, Div. 1, Groups A,B,C,D; EXIa IIC, T4; Class I, Zone 0, AEXIa IIC, T4  
Vmax = 14.5Vdc

4-20mA with integral connector	4-20mA with upto 1000ft of integral cable	All EXCEPT 4-20mA with integral connector	All EXCEPT 4-20mA with upto 150ft of integral cable
Pmax = 625 mW Imax = 93 mA Ci = 0.391 uF Li = 0	Pmax = 625 mW Imax = 93 mA Ci = 0.434 uF Li = 155 uH	Pmax = 625 mW Imax = 93 mA Ci = 0.643 uF Li = 0	Pmax = 625 mW Imax = 93 mA Ci = 0.649 uF Li = 23.3 uH

1. For installation in accordance with Fig 2, barrier must be a CSA Certified, Single Channel grounded Shunt-Diode Zener Barrier or a Single Channel Isolating Barrier.

2. For installations in accordance with Figs 1 and 3, one dual-channel or two single-channel barriers may be used, where in either case, both channels have been Certified for use together with combined entity parameters.

3. The following conditions must be satisfied:

$$V_{oc} \text{ or } U_o \leq V_{max}$$

$$I_{sc} \text{ or } I_o \leq I_{max}$$

$$P_o \leq P_i \text{ (if applicable)}$$

$$C_a \text{ or } C_o \geq C_i + C_{cable}$$

$$L_a \text{ or } L_o \geq L_i + L_{cable}$$

4. Maximum non-hazardous area voltage must not exceed 250 V.

5. Canadian installations should be in accordance with Canadian Electrical Code, Part I. U.S. installations should be in accordance with Article 504 in the National Electrical Code, ANSI/NFPA 70.

6. A grounding method is not provided by the manufacturer as part of the integral design of the Transducer. For units which are connected through a grounded shunt diode safety barrier, ensure that the transducer is mounted to a surface which is at the same potential as the barrier ground.

7. See user manual for installation conditions.

Note: Float unused wires in cable. Insure that these wires are electrically isolated from other conductors

Legend	
✓	Standard Available
X	Not Available

**Available Process Connection, Material Configurations & Pressure Codes**

**17-4PH PSI**

Pressure Range	Pressure Range Code	PSI Unit	Process Connection Code						
			A	B	C	F	I	P	W
-14.7 - 25	V0025	P	✓	X	✓	X	✓	✓	X
-14.7 - 50	V0050	P	✓	✓	✓	✓	✓	✓	X
-14.7 - 100	V0100	P	✓	✓	✓	✓	✓	✓	X
-14.7 - 150	V0150	P	✓	✓	✓	✓	✓	✓	X
-14.7 - 200	V0200	P	✓	✓	✓	✓	✓	✓	X
-14.7 - 250	V0250	P	✓	✓	✓	✓	✓	✓	X
-14.7 - 500	V0500	P	✓	✓	✓	✓	✓	✓	X
0 - 25	00025	P	✓	X	✓	X	✓	✓	X
0 - 50	00050	P	✓	✓	✓	✓	✓	✓	X
0 - 100	00100	P	✓	✓	✓	✓	✓	✓	X
0 - 150	00150	P	✓	✓	✓	✓	✓	✓	X
0 - 200	00200	P	✓	✓	✓	✓	✓	✓	X
0 - 250	00250	P	✓	✓	✓	✓	✓	✓	X
0 - 500	00500	P	✓	✓	✓	✓	✓	✓	X
0 - 1,000	01000	P	✓	✓	✓	✓	✓	✓	X
0 - 2,500	02500	P	✓	✓	✓	✓	✓	✓	X
0 - 5,000	05000	P	✓	✓	✓	✓	✓	✓	X
0 - 7,500	07500	P	X	X	✓	✓	✓	✓	X
0 - 10,000	10000	P	X	X	X	X	X	X	✓

**17-4PH Bar**

Pressure Range	Pressure Range Code	BAR Unit	Process Connection Code						
			A	B	C	F	I	P	W
-1 to 2	V0002	B	✓	✓	✓	✓	✓	✓	X
-1 to 5	V0005	B	✓	✓	✓	✓	✓	✓	X
-1 to 7	V0007	B	✓	✓	✓	✓	✓	✓	X
-1 to 10	V0010	B	✓	✓	✓	✓	✓	✓	X
-1 to 20	V0020	B	✓	✓	✓	✓	✓	✓	X
0-2	00002	B	✓	✓	✓	✓	✓	✓	X
0-5	00005	B	✓	✓	✓	✓	✓	✓	X
0-7	00007	B	✓	✓	✓	✓	✓	✓	X
0-10	00010	B	✓	✓	✓	✓	✓	✓	X
0-20	00020	B	✓	✓	✓	✓	✓	✓	X
0-35	00035	B	✓	✓	✓	✓	✓	✓	X
0-50	00050	B	✓	✓	✓	✓	✓	✓	X
0-100	00100	B	✓	✓	✓	✓	✓	✓	X
0-250	00250	B	✓	✓	✓	✓	✓	✓	X
0-350	00350	B	✓	✓	✓	✓	✓	✓	X
0-500	00500	B	✓	✓	✓	✓	✓	✓	X
0-700	00700	B	✓	✓	✓	✓	✓	✓	X



## INDUSTRIAL OEM

AST4400 Pressure Transmitter

### 316L PSI

Pressure Range	Pressure Range Code	PSI Unit	Process Connection Code						
			A	B	C	F	I	P	W
-14.7 - 25	V0025	P	✓	X	✓	X	✓	✓	X
-14.7 - 50	V0050	P	✓	X	✓	✓	✓	✓	X
-14.7 - 100	V0100	P	✓	X	✓	✓	✓	✓	X
-14.7 - 150	V0150	P	✓	X	✓	✓	✓	✓	X
-14.7 - 200	V0200	P	✓	X	✓	✓	✓	✓	X
-14.7 - 250	V0250	P	✓	X	✓	✓	✓	✓	X
-14.7 - 500	V0500	P	✓	X	✓	✓	✓	✓	X
0 - 25	00025	P	✓	X	✓	X	✓	✓	X
0 - 50	00050	P	✓	X	✓	✓	✓	✓	X
0 - 100	00100	P	✓	X	✓	✓	✓	✓	X
0 - 150	00150	P	✓	X	✓	✓	✓	✓	X
0 - 200	00200	P	✓	X	✓	✓	✓	✓	X
0 - 250	00250	P	✓	X	✓	✓	✓	✓	X
0 - 500	00500	P	✓	X	✓	✓	✓	✓	X
0 - 1,000	01000	P	✓	X	✓	✓	✓	✓	X
0 - 2,500	02500	P	✓	X	✓	✓	✓	✓	X
0 - 5,000	05000	P	✓	X	✓	✓	✓	✓	X
0 - 7,500	07500	P	✓	X	✓	✓	✓	✓	X
0 - 10,000	10000	P	✓	X	✓	✓	✓	✓	X
0 - 15,000	15000	P	X	X	X	✓	✓	X	X
0 - 20,000	20000	P	X	X	X	X	X	X	✓

### 316L Bar

Pressure Range	Pressure Range Code	BAR Unit	Process Connection Code						
			A	B	C	F	I	P	W
-1 to 2	V0002	B	✓	X	✓	✓	✓	✓	X
-1 to 5	V0005	B	✓	X	✓	✓	✓	✓	X
-1 to 7	V0007	B	✓	X	✓	✓	✓	✓	X
-1 to 10	V0010	B	✓	X	✓	✓	✓	✓	X
-1 to 20	V0020	B	✓	X	✓	✓	✓	✓	X
0-2	00002	B	✓	X	✓	✓	✓	✓	X
0-5	00005	B	✓	X	✓	✓	✓	✓	X
0-7	00007	B	✓	X	✓	✓	✓	✓	X
0-10	00010	B	✓	X	✓	✓	✓	✓	X
0-20	00020	B	✓	X	✓	✓	✓	✓	X
0-35	00035	B	✓	X	✓	✓	✓	✓	X
0-50	00050	B	✓	X	✓	✓	✓	✓	X
0-100	00100	B	✓	X	✓	✓	✓	✓	X
0-250	00250	B	✓	X	✓	✓	✓	✓	X
0-350	00350	B	✓	X	✓	✓	✓	✓	X
0-500	00500	B	✓	X	✓	✓	✓	✓	X
0-700	00700	B	✓	X	✓	✓	✓	✓	X

# INDUSTRIAL OEM

AST4400 Pressure Transmitter

## Inconel PSI

Pressure Range	Pressure Range Code	PSI Unit	Process Connection Code						
			A	B	C	F	I	P	W
-14.7 - 25	V0025	P	✓	X	X	X	X	✓	X
-14.7 - 50	V0050	P	✓	X	X	X	X	✓	X
-14.7 - 100	V0100	P	✓	X	X	X	X	✓	X
-14.7 - 150	V0150	P	✓	X	X	X	X	✓	X
-14.7 - 200	V0200	P	✓	X	X	X	X	✓	X
-14.7 - 250	V0250	P	✓	X	X	X	X	✓	X
-14.7 - 500	V0500	P	✓	X	X	X	X	✓	X
0 - 25	00025	P	✓	X	X	X	X	✓	X
0 - 50	00050	P	✓	X	X	X	X	✓	X
0 - 100	00100	P	✓	X	X	X	X	✓	X
0 - 150	00150	P	✓	X	X	X	X	✓	X
0 - 200	00200	P	✓	X	X	X	X	✓	X
0 - 250	00250	P	✓	X	X	X	X	✓	X
0 - 500	00500	P	✓	X	X	X	X	✓	X
0 - 1,000	01000	P	✓	X	X	X	X	✓	X
0 - 2,500	02500	P	✓	X	X	X	X	✓	X
0 - 5,000	05000	P	✓	X	X	X	X	✓	X
0 - 7,500	07500	P	✓	X	X	X	X	✓	X
0 - 10,000	10000	P	✓	X	X	X	X	✓	X
0 - 15,000	15000	P	X	X	X	X	✓	✓	X
0 - 20,000	20000	P	X	X	X	X	X	X	✓

## Inconel Bar

Pressure Range	Pressure Range Code	BAR Unit	Process Connection Code						
			A	B	C	F	I	P	W
-1 to 2	V0002	B	✓	X	X	X	X	✓	X
-1 to 5	V0005	B	✓	X	X	X	X	✓	X
-1 to 7	V0007	B	✓	X	X	X	X	✓	X
-1 to 10	V0010	B	✓	X	X	X	X	✓	X
-1 to 20	V0020	B	✓	X	X	X	X	✓	X
0-2	00002	B	✓	X	X	X	X	✓	X
0-5	00005	B	✓	X	X	X	X	✓	X
0-7	00007	B	✓	X	X	X	X	✓	X
0-10	00010	B	✓	X	X	X	X	✓	X
0-20	00020	B	✓	X	X	X	X	✓	X
0-35	00035	B	✓	X	X	X	X	✓	X
0-50	00050	B	✓	X	X	X	X	✓	X
0-100	00100	B	✓	X	X	X	X	✓	X
0-250	00250	B	✓	X	X	X	X	✓	X
0-350	00350	B	✓	X	X	X	X	✓	X
0-500	00500	B	✓	X	X	X	X	✓	X
0-700	00700	B	✓	X	X	X	X	✓	X

# INDUSTRIAL OEM

AST4400 Pressure Transmitter

## Hastelloy PSI

Pressure Range	Pressure Range Code	PSI Unit	Process Connection Code						
			A	B	C	F	I	P	W
-14.7 - 25	V0025	P	✓	X	✓	X	X	✓	X
-14.7 - 50	V0050	P	✓	X	✓	X	X	✓	X
-14.7 - 100	V0100	P	✓	X	✓	X	X	✓	X
-14.7 - 150	V0150	P	✓	X	✓	X	X	✓	X
-14.7 - 200	V0200	P	✓	X	✓	X	X	✓	X
-14.7 - 250	V0250	P	✓	X	✓	X	X	✓	X
-14.7 - 500	V0500	P	✓	X	✓	X	X	✓	X
0 - 25	00025	P	✓	X	✓	X	X	✓	X
0 - 50	00050	P	✓	X	✓	X	X	✓	X
0 - 100	00100	P	✓	X	✓	X	X	✓	X
0 - 150	00150	P	✓	X	✓	X	X	✓	X
0 - 200	00200	P	✓	X	✓	X	X	✓	X
0 - 250	00250	P	✓	X	✓	X	X	✓	X
0 - 500	00500	P	✓	X	✓	X	X	✓	X
0 - 1,000	01000	P	✓	X	✓	X	X	✓	X
0 - 2,500	02500	P	✓	X	✓	X	X	✓	X
0 - 5,000	05000	P	✓	X	✓	X	X	✓	X
0 - 7,500	07500	P	✓	X	✓	X	X	✓	X
0 - 10,000	10000	P	✓	X	✓	X	X	✓	X
0 - 15,000	15000	P	X	X	✓	X	X	✓	X
0 - 20,000	20000	P	X	X	X	X	X	X	X

## Hastelloy Bar

Pressure Range	Pressure Range Code	BAR Unit	Process Connection Code						
			A	B	C	F	I	P	W
-1 to 2	V0002	B	✓	X	✓	X	X	✓	X
-1 to 5	V0005	B	✓	X	✓	X	X	✓	X
-1 to 7	V0007	B	✓	X	✓	X	X	✓	X
-1 to 10	V0010	B	✓	X	✓	X	X	✓	X
-1 to 20	V0020	B	✓	X	✓	X	X	✓	X
0-2	00002	B	✓	X	✓	X	X	✓	X
0-5	00005	B	✓	X	✓	X	X	✓	X
0-7	00007	B	✓	X	✓	X	X	✓	X
0-10	00010	B	✓	X	✓	X	X	✓	X
0-20	00020	B	✓	X	✓	X	X	✓	X
0-35	00035	B	✓	X	✓	X	X	✓	X
0-50	00050	B	✓	X	✓	X	X	✓	X
0-100	00100	B	✓	X	✓	X	X	✓	X
0-250	00250	B	✓	X	✓	X	X	✓	X
0-350	00350	B	✓	X	✓	X	X	✓	X
0-500	00500	B	✓	X	✓	X	X	✓	X
0-700	00700	B	✓	X	✓	X	X	✓	X
0-1,000	01000	B	X	X	✓	X	X	✓	X

\*See Ordering Information for list of options.

# INDUSTRIAL OEM

AST4400 Pressure Transmitter

## Ordering Information

<b>AST4400</b>	<b>A</b>	<b>00500</b>	<b>P</b>	<b>4</b>	<b>L</b>	<b>1</b>	<b>000</b>	<b>-SS</b>
<b>Process Connection</b> A= 1/4" NPT Male                      I= 1/4" NPT Female B= 1/8" NPT Male                     P= 1/2" NPT Male C= 1/4" BSPP Male                    W= F250C Female Autoclave F= 7/16"-20 UNF Male								
<b>Pressure Range</b> Insert Pressure Range Code (see table for availability)								
<b>Pressure Unit</b> B= Bar            P= PSI								
<b>Output</b> 1= 0.5-4.5V ratiometric                6= 1-6V 3= 1-5V 4= 4-20mA (2 wire loop powered)								
<b>Electrical Connection</b> A= 2 ft. (0.6m)                            L= Conduit, Cable 2 ft. (0.6 m) B= 4 ft. (1.2m)                            M= Conduit, Cable 4 ft. (1.2 m) C= 6 ft. (1.8m)                            N= Conduit, Cable 6 ft. (1.8 m) D= 10 ft. (3.0m)                          P= Conduit, Cable 10 ft. (3 m) E= Mini DIN 43650C                       R= 6- Pin Bendix F= Packard Metripack 150 3-Pin        Y= M12x1 I= DIN 43650A                              4 = Mini-Fast (-SS Only)								
<b>Wetted Material</b> 0= 17-4PH    1= 316L    2= Inconel 718    4= Hastelloy C276								
<b>Option Codes</b> 000= No Options								
<b>Approval Type</b>								
-SS	CSA157 Class I Div 1 Grps C, D & Class I Zone 0, AEx ia IIB T4 Intrinsically Safe when installed with approved barrier, ANSI/ISA 12.27.01 Single Seal and ATEX/IECEX Exia IIB T4  Electrical Connection F not available							
-Z	CRN Registered to ANSI/ASME B31.3. Contact factory for material, pressure, and process connection options (includes -SS approvals)  Electrical Connection F not available							
Leave Blank	UL ANSI/ISA 12.12.01 Class I Div 1 Intrinsically Safe Groups C, D (formerly UL913)  Not available for Electrical Connection 4							

Note: CSA approved products require case/earth ground electrical connection. See wiring installation sheet for further details

### NORTH AMERICA

American Sensor Technologies, Inc. (AST),  
a TE Connectivity Company  
Tel: 800-522-6752  
Email: [customercare.molive@te.com](mailto:customercare.molive@te.com)

### ASIA

Hong Kong Sensor Technologies (HKST),  
a TE Connectivity Company  
Tel: 0400-820-6015  
Email: [customercare.shzn@te.com](mailto:customercare.shzn@te.com)

### TE.com/sensors

Measurement Specialties, Inc., a TE Connectivity company.

Measurement Specialties, TE Connectivity, TE Connectivity (logo) and EVERY CONNECTION COUNTS are trademarks. All other logos, products and/or company names referred to herein might be trademarks of their respective owners.

The information given herein, including drawings, illustrations and schematics which are intended for illustration purposes only, is believed to be reliable. However, TE Connectivity makes no warranties as to its accuracy or completeness and disclaims any liability in connection with its use. TE Connectivity's obligations shall only be as set forth in TE Connectivity's Standard Terms and Conditions of Sale for this product and in no case will TE Connectivity be liable for any incidental, indirect or consequential damages arising out of the sale, resale, use or misuse of the product. Users of TE Connectivity products should make their own evaluation to determine the suitability of each such product for the specific application.