

# SLT190 LINEAR POSITION TRANSDUCER

# INNOVATION IN MOTION

The SLT190 linear position transducer is designed to provide reliable, fit-and-forget position sensing within a compact transducer size for the most arduous operating environments. The transducer uses an innovative single coil inductive operating principle within a rugged, stainless steel housing and provides an analogue position signal proportional to the operating sleeve position. Offering one of the most cost-effective solutions for contactless absolute position sensing, this transducer is ideally suited to exterior mounting on off-highway vehicle systems, including military vehicles.

## Impressive environmental capability

The SLT190 has been designed with 21st century applications in mind. The transducer can withstand operating temperatures from -40°C to +150°C and has been tested to withstand shocks to 10,000g. With an EMC Immunity of 100V/m, this transducer is ready for the harshest applications, such as steel and aluminium plants and power generating stations.



## Choice of transducer strokes

The SLT190 is available with 14 different strokes from 25 to 500mm and has a short body-to-stroke-length ratio. This makes it ideal for the replacement of linear potentiometers in hostile operating conditions, whilst providing a cost saving over equivalent stroke length inductive transducers, such as LVDTs.

## Features

- No contact between the sensing elements
- Compact body to stroke length
- Infinite resolution
- Absolute measurement
- Rugged stainless steel construction
- High temperature capability to +150°C (+302°F)
- CE approved
- Rapid despatch of any length

## Benefits

- Virtually infinite life
- Reduced installation space
- All displacement will be sensed
- No loss of position on power down
- Maximum reliability under impact and vibration
- Maximum reliability in hostile environments
- Confidence in EMC performance
- Eliminates customer inventory



### EMC Directive 2004/108/EC

The products detailed in this document have been tested to the requirements of EN61000-6-3 (Emissions) and EN61000-6-2 (Immunity).



### Quality Assurance

Penny+Giles are accredited to BS EN ISO9001:2008. Quality is at the heart of all our systems ensuring the reliability of our products from initial design to final despatch.

Certificate No. LRQ 0924881

# SLT190 LINEAR POSITION TRANSDUCER



## **Rugged mounting style**

The patented operating principle of the SLT190 position transducer uses a core moving within the transducer body to supply the signal proportional to outer sleeve displacement. The outer sleeve design is captive, with the sleeve and transducer bodies both having a rugged M8 self-aligning, stainless steel bearing included for simple installation. The M8 size allows the transducer to be mounted on an 8mm or 5/16in mounting pin.

## **Separate signal conditioning**

To minimise the transducer size and the impact on the overall system, we provide separate signal conditioning electronics (EICT or EICTM) housed in rugged IP66 or IP68 rated enclosures. The electronics module can be located up to 10m away from the transducer, well away from any hostile conditions (vibration, mechanical impact, temperature) that the position transducer may encounter during operation. The result is a more reliable transducer solution, easily installed and adjusted and more flexible in the choice of outputs available – including voltage, current and digital PWM.



## **Total reliability**

The SLT190 provides a highly reliable solution for absolute position sensing in a variety of applications. The contactless operating principle (with no electrical sliding contacts) allows a fit-and-forget installation so that zero maintenance programs can be incorporated within plant or equipment service schedules.

## **World leading availability**

The SLT190 has been 'designed for manufacture' enabling assembly in a state-of-the-art manufacturing cell. This means that we can supply any one of the 14 different stroke lengths in a matter of days from ordering. This allows OEMs to reduce or eliminate their inventory, and call on Penny+Giles to supply 'on demand'.

## **Performance assured**

Penny+Giles' product development process includes exhaustive qualification testing to ensure that performance specifications published in our product brochures and technical data sheets are backed by real-life test evidence. This is our assurance to you that our designs have been tested at these parameters.

# SLT 190 LINEAR POSITION TRANSDUCER

## PERFORMANCE

### ELECTRICAL

<b>Electrical stroke range E</b>	<b>mm</b>	25 to 500
<b>Stroke increments</b>	<b>mm</b>	25 to 200 in 25mm increments 250 to 500 in 50mm increments
<b>Non-Linearity*</b>	<b>%</b>	Enhanced - typically less than $\pm 0.2\%$ of total stroke, $\pm 0.25\%$ maximum (code A) Standard - typically less than $\pm 0.4\%$ of total stroke, $\pm 0.5\%$ maximum (code B)
<b>Resolution</b>		Virtually infinite
<b>Temperature coefficient</b>	<b>ppm/°C</b>	< $\pm 100$ ppm of electrical stroke/°C (+20 to +60°C) < $\pm 200$ ppm of electrical stroke/°C (-20 to +100°C) < $\pm 300$ ppm of electrical stroke/°C (-20 to +150°C)
<b>Insulation resistance</b>		Greater than 50M $\Omega$ at 50Vdc

\*Non-linearity is measured using the Least-Squares method on a computerised calibration system

### MECHANICAL

<b>Mechanical stroke range</b>	<b>mm</b>	Electrical stroke +3mm overstroke at each end
<b>Mounting</b>		via M8 stainless steel rod end bearings. Suitable for mounting on 8mm or 5/16in bolts
<b>Operating force</b>	<b>gf</b>	< 500 in horizontal plane (vented sleeve)
<b>Shaft velocity - maximum</b>	<b>m/s</b>	5 (see EICT performance for frequency response)
<b>Weight</b>	<b>g</b>	see dimensions on page 5

### ENVIRONMENTAL

<b>Protection class</b>		IP67
<b>Operational temperature</b>	<b>°C</b>	-40 to +150
<b>Storage temperature</b>	<b>°C</b>	-50 to +150
<b>Life</b>		Contactless - no limitation to electrical life. Mechanical life is tested to 100 million operations (5x10 <sup>6</sup> cycles), actual service life is dependant on installation and application.
<b>Vibration</b>		RTCA/DO-160E 10Hz to 2000Hz, 11.23g (rms) - radial axis only
<b>Shock</b>		Survival to 10000g - radial axis
<b>EMC Immunity level</b>		Transducer can withstand a threat of 100V/m

**The performance specified is only valid when the SLT190 is operated in conjunction with the signal conditioning unit - model EICT or EICTM.**

### OPTIONS

<b>Non-linearity</b>	Standard (code B $\pm 0.5\%$ max), or Enhanced (code A $\pm 0.25\%$ max) can be specified
<b>Extended cable length</b>	1m or 6m output cable can be specified

### AVAILABILITY

All configurations can be supplied within ten days from the factory

### ORDERING CODE

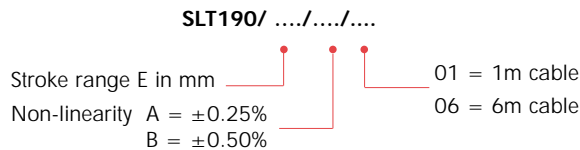

## SIGNAL CONDITIONING

**Input voltage** Vdc  
**Output voltage**  
     **standard** Vdc  
     **options** Vdc  
**Output current - option** mA  
**Output PWM**

See page 6 for full EICT module performance and dimensions  
 +10 to +60 nominal

0.5 to 4.5  
 0 to 5, 0 to 10, ±2.5, ±5, ±7.5, ±10 (using Voltage Module **VM** output option card)  
 4 to 20 (using Current Module **CM** output option card)  
 TTL level compatible signal with a 10-90% duty cycle proportional to transducer displacement (using Pulse Width Modulation **PWM** output option card)

The transducer is supplied with a Sensor Calibration Module Card (**SCMC**) which is calibrated to match the transducer electrical stroke. This card must be inserted into the **EICT** signal conditioning unit before operation. Full details on installation and set-up are included in the manual supplied with the EICT module.

## DIMENSIONS

Note: drawings not to scale

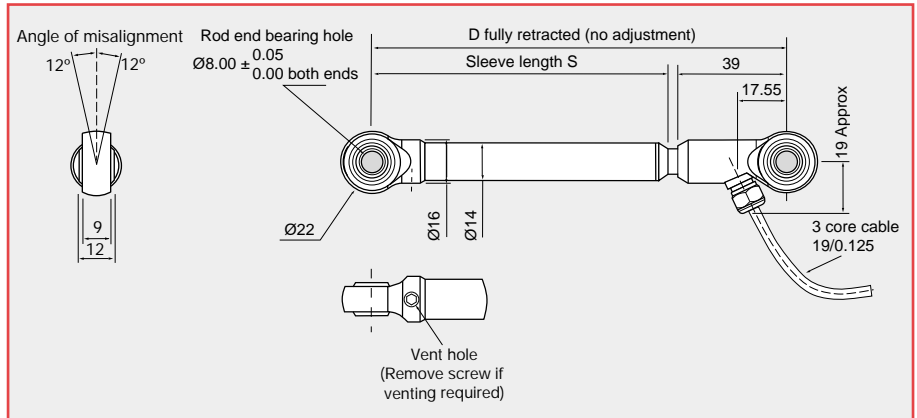

<b>Electrical stroke E</b>	mm	25	50	75	100	125	150	175	200	250	300	350	400	450	500
<b>Mechanical stroke M</b>	mm	31	56	81	106	131	156	181	206	256	306	356	406	456	506
<b>Sleeve length S</b>	mm	132	157	182	207	232	257	282	307	357	407	457	507	557	607
<b>Distance between centres D</b>	mm	175	200	225	250	275	300	325	350	400	450	500	550	600	650
<b>Approximate weight</b>	g	239	258	277	296	314	333	352	370	408	446	483	520	558	595

## ELECTRICAL CONNECTIONS

3 core cable: FEP sheathed 1m or 6m long with PTFE insulated 19/0.125 cores. 90% braided screen.

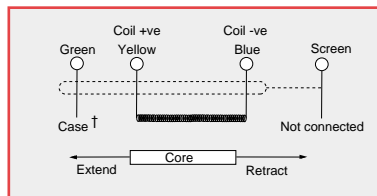

Recommended cable minimum bend radius is 10mm

† The Green wire is internally connected to the transducer case. However, due to the construction of the transducer external moving parts, the Green connection should not be used as a ground connection.

# EICT SIGNAL CONDITIONING MODULE

The EICT signal conditioning module has been specifically designed to operate the SLT190 and ICT range of contactless linear position transducers. This module incorporate a high performance circuit that drives the transducer and provides a choice of output signals with zero and span adjustment for simple user configuration. The module can be supplied in a choice of enclosures, with sealing to IP66 or IP68 protection.

## PERFORMANCE

**Supply voltage, unregulated Vdc**  
limited to 13.5 min. on certain ranges - see options table

10 - 60 or  $\pm(10 - 30)$  for standard output voltage range (**EICT** only)  
 10 - 30 or  $\pm(10 - 30)$  for extended output voltage range (**VM** card fitted)  
 10 - 30 or  $\pm(10 - 30)$  for current output (**CM** card fitted) or pulse width modulated output (**PWM** card fitted)

**Supply current** mA

10 maximum (19 with **VM** card fitted, 12.6 plus output current with **CM** card fitted, 13 with **PWM** card fitted)

**Output voltage signal** Vdc

0.5-4.5 See details on page 7 for additional output options

**Output current signal** mA

4-20 See details on page 7 for options

**Output PWM signal**

TTL level compatible signal with a 10-90% duty cycle. See details on page 7

**Output ripple** mVrms

<5

**Output load**  $\Omega$

10k minimum (resistive to 0V line)

**Frequency response** Hz

30 (-3dB) [equivalent to 5ms output lag]

**Line regulation**

<0.001% output span/Volt

**Power on settlement**

Within 0.25% of final output in less than 300 milliseconds

**Output adjustment range**

zero adjustment

-10 to 60% of span

gain adjustment

40 to 110% of span

**Operational temperature** °C

0 to +70

**Storage temperature** °C

-40 to +85

**Temperature stability** ppm/°C

200 (300 if VM card fitted)

**EMC Immunity level**

EN61000-6-2: 10kHz to 1GHz

Threat 100V/m : derangement <0.05% FS (**EICTM** module, adjacent to transducer)

Threat 10V/m : derangement <0.05% FS (**EICT** module, 1m cable)

**Transducer types**

Will only operate Penny+Giles SLT190 and ICT range of transducers

**Mechanical housing**

**EICT** - corrosion resistant plastic enclosure sealed to IP66, with detail to fit rail DIN EN50022 or EN50035 or bulkhead mount via four M5 screws.

**EICTM** - powder coated metal enclosure sealed to IP68 with bulkhead mounting only.

**Weight maximum** g

105 (250 for EICTM)

**Maximum recommended distance between transducer and EICT module is 10m.**

## OUTPUT CHARACTERISTICS

**EICT standard unit**  
10 - 60Vdc supply

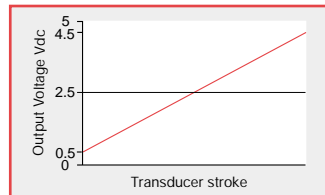

**EICT with VM card fitted**  
10 - 30Vdc supply

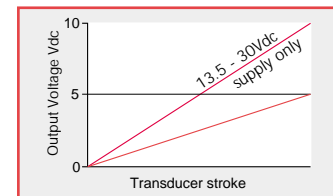

**EICT with CM card fitted**  
10 - 30Vdc or  $\pm(10 - 30)$  Vdc supply

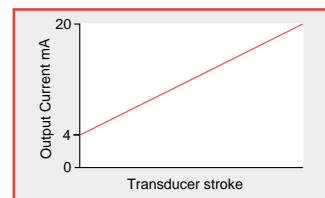

**EICT with VM card fitted**  
10 - 30Vdc or  $\pm(10 - 30)$  Vdc supply

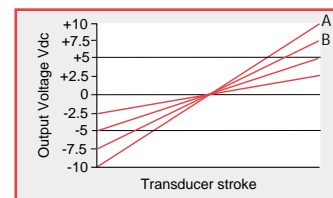

Note: A and B outputs only available with a  $\pm(13.5 - 30)$  Vdc supply

### Notes:

- The SLT190 transducer is supplied with a Sensor Calibration Module Card (SCMC) which is calibrated to match the transducer electrical stroke. This card must be inserted into the EICT signal conditioning unit before operation. The EICT is user configurable for input and output options.

Full details on installation and set-up are included in the manual supplied with the EICT module.

## OUTPUT OPTIONS

Output option	Supply voltage range Vdc Single or (Dual) supply	EICT	EICT with VM option card	EICT with CM option card	EICT with PWM option card
0.5 - 4.5Vdc	10 - 60 or ±(10 - 30)	✓	N/A	N/A	N/A
0 - 5Vdc	10 - 30 or ±(10 - 30)	N/A	✓	N/A	N/A
0 - 10Vdc	13.5 - 30 or ±(13.5 - 30)	N/A	✓	N/A	N/A
±2.5Vdc	10 - 30 or ±(10 - 30)	N/A	✓	N/A	N/A
±5Vdc	10 - 30 or ±(10 - 30)	N/A	✓	N/A	N/A
±7.5Vdc	13.5 - 30 or ±(13.5 - 30)	N/A	✓	N/A	N/A
±10Vdc	13.5 - 30 or ±(13.5 - 30)	N/A	✓	N/A	N/A
4 - 20mA	10 - 30 or ±(10 - 30)	N/A	N/A	✓	N/A
TTL (10-90%)	10 - 30 or ±(10 - 30)	N/A	N/A	N/A	✓
Slope reversal		✓	✓	✓	✓

### PWM output signal

Output frequencies	Hz
Frequency accuracy	%
Output levels	Vdc
Rise/Fall time	µS
Output range	%

TTL level compatible signal with a 10-90% duty cycle

100, 130, 310, 1000 (user selected)

±10

LOGIC HIGH 4.5 ±0.5

LOGIC LOW <0.4

<2 with 1nF. load capacitance

10 (zero) to 90 (span)

Continual development of output options means we are working on additional **EICT** module output options. Please ask for details

## DIMENSIONS

Note: drawings not to scale

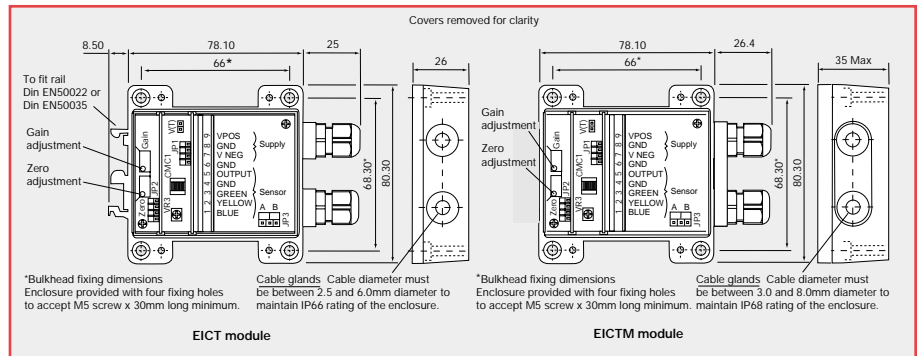

## ELECTRICAL CONNECTIONS

Screw terminals

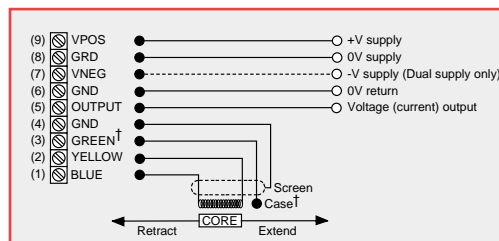

Misconnection of the supply may cause permanent damage

† The Green wire is internally connected to the transducer case. However, due to the construction of the transducer external moving parts, the Green connection should not be used as a ground connection.

**Note:** refer to the EICT set-up guide for details on how to connect to a split rail power supply.

## AVAILABILITY

Normally available from stock

## ORDERING CODES

**EICT** - module with 0.5 to 4.5Vdc output, IP66 protected plastic housing

**EICTM** - module with 0.5 to 4.5Vdc output, IP68 protected metal housing

## ACCESSORIES order separately

**VM** - voltage module output option card

**CM** - current module output option card

**PWM** - pulse width modulation output option card



[www.pennyandgiles.com](http://www.pennyandgiles.com)

**Penny & Giles**

Position sensors, joysticks and solenoids for commercial and industrial applications.

15 Airfield Road  
Christchurch  
Dorset BH23 3TG  
United Kingdom  
+44 (0) 1202 409499  
+44 (0) 1202 409475 Fax  
sales@pennyandgiles.com

36 Nine Mile Point Industrial Estate  
Cwmfelinfach  
Gwent NP11 7HZ  
United Kingdom  
+44 (0) 1495 202000  
+44 (0) 1495 202006 Fax  
sales@pennyandgiles.com

665 North Baldwin Park Boulevard  
City of Industry, CA 91746  
USA  
+1 626 480 2150  
+1 626 369 6318 Fax  
us.sales@pennyandgiles.com

Straussenlettenstr. 7b  
85053 Ingolstadt,  
Germany  
+49 (0) 841 885567-0  
+49 (0) 841 885567-67 Fax  
info@penny-giles.de

3-1-A, Xiandai Square,  
No 333 Xingpu Rd,  
Suzhou Industrial Park, 215126  
China  
+86 512 6287 3380  
+86 512 6287 3390 Fax  
sales@pennyandgiles.com.cn

The information contained in this brochure on product applications should be used by customers for guidance only. Penny+Giles Controls Ltd makes no warranty or representation in respect of product fitness or suitability for any particular design application, environment, or otherwise, except as may subsequently be agreed in a contract for the sale and purchase of products. Customer's should therefore satisfy themselves of the actual performance requirements and subsequently the products suitability for any particular design application and the environment in which the product is to be used.

Continual research and development may require change to products and specification without prior notification. All trademarks acknowledged.

© Penny+Giles Controls Ltd 2012

Innovation In Motion

